

Intermediate Elements · with support
EH 23700.

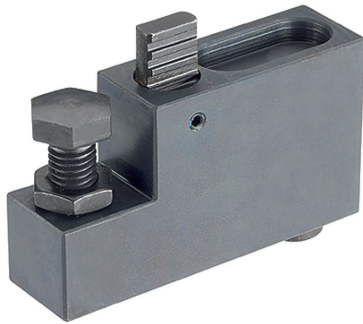

Product Description

Material

Body

- Steel, blackened

Wearing parts

- Heat-treated steel

Pull-rod

- Special steel

Drawing

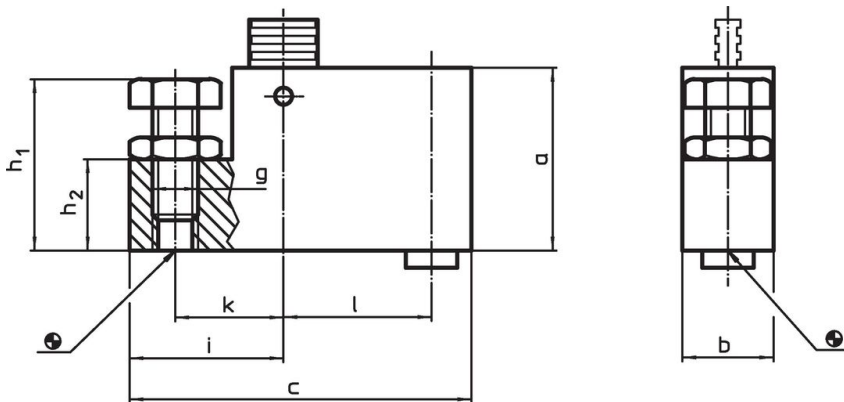

Order information

a	b	c	g	Dimensions					[g]	Art. No.
				h_1 [mm]	h_2	i	k	l		
50	25	92	M12	38 – 53	25	39.5	28	40	733	23700.0212
60	30	112	M16	48 – 68	30	48.0	34	50	1331	23700.0216

Application example

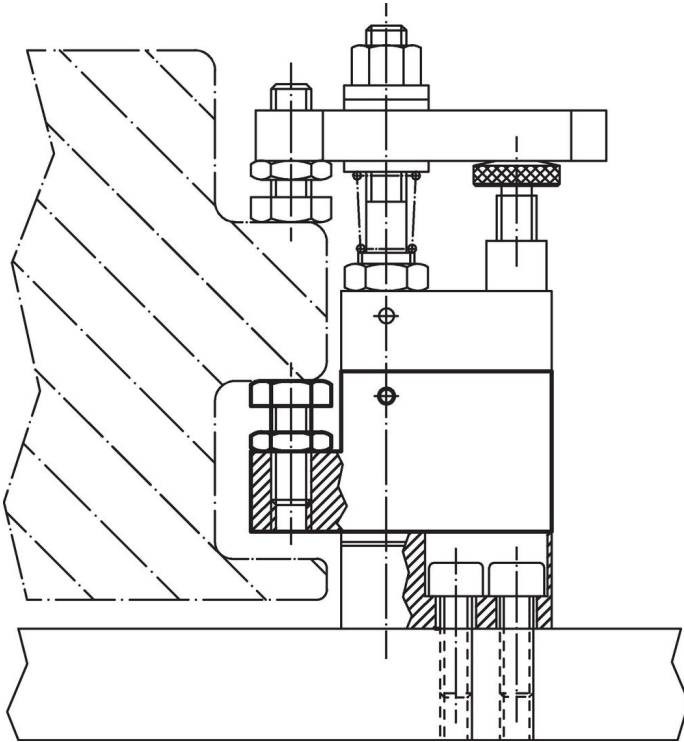

Compliance

RoHS compliant

Compliant according to Directive 2011/65/EU and Directive 2015/863.

Does not contain SVHC substances

No SVHC substances with more than 0.1% w/w contained - SVHC list [REACH] as of 23.01.2024.

Does not contain Proposition 65 substances

No Proposition 65 substances included.

<https://www.P65Warnings.ca.gov/>

Free from Conflict Minerals

This product does not contain any substances designated as "conflict minerals" such as tantalum, tin, gold or tungsten from the Democratic Republic of Congo or adjacent countries.