

Compact Clamps

EH 23690.



Product Description

The compact clamps are all purpose clamping elements. Due to the self-locking tension lever application can either take place in horizontal or vertical position in both, machined and raw workpieces.

Features:

- Exact and position precise clamping
- Easy, universal handling
- High clamping force at low tightening torques, abrasion-resistant due to tension lever with bearings
- Continuous, large clamping area
- Tension lever entirely retractable for hindrance-free exchange of workpieces
- Tension lever with locating thread for various clamping elements, e.g. ball-ended thrust screws (EH 22700. - EH 22720.), self-aligning pads (EH 22730. / EH 22740.) etc.
- Large adjusting range at constant clamping force
- Continuous increase of the clamping range by height adapters 23690.0112 / .0116
- Easy and flexible mounting options
- Corrosion-resistant
- Resistant to dirt and chips

Material

Body

- Heat-treated steel, black coated

Tension lever

- Heat-treated steel, tempered, silver coated

Assembly

Assembly and Set-Up:

1. Take out stop pin ISO 4762-M 6 x 10.
2. Move back and take out tension lever.
3. Tightening by 2 screws with internal hexagon (included in supply volume).
4. Place tension lever in sliding rail and then insert.
5. Tighten stop pin ISO 4762 - M 6 x 10.

Operation

Clamping Process:

1. Slide tension lever to clamping position.
2. Clamping is made via a hexagon collar screw.
3. Releasing is done in reverse order.

More information

Further products

- Height Adapters, for compact clamp

Drawing

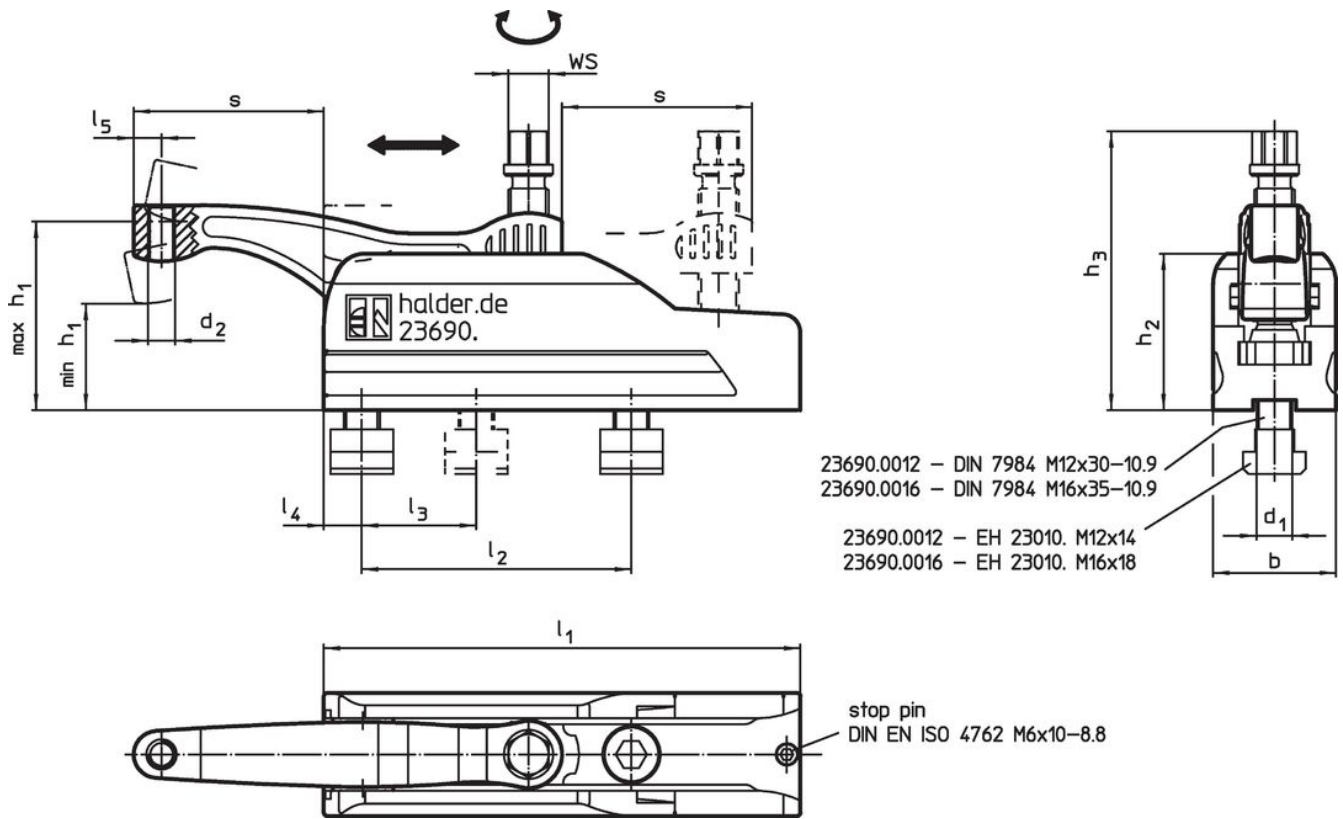

Order information

d_1	d_2	h_1 min.	h_1 max.	h_2	h_3	Dimensions							WS [mm]	Clamping force max. [kN]	Tightening torque max. [Nm]	🔩 [g]	Art. No.
						s max. [mm]	l_1	l_2 +1	l_3	l_4	l_5	b					
M12	M 8	40	60	59	95	43	134	70	50	13	10.0	45	16	15	45	1840	23690.0012
M16	M12	47	85	70	126	85	213	120	50	17	12.5	55	18	25	75	4000	23690.0016

Application example

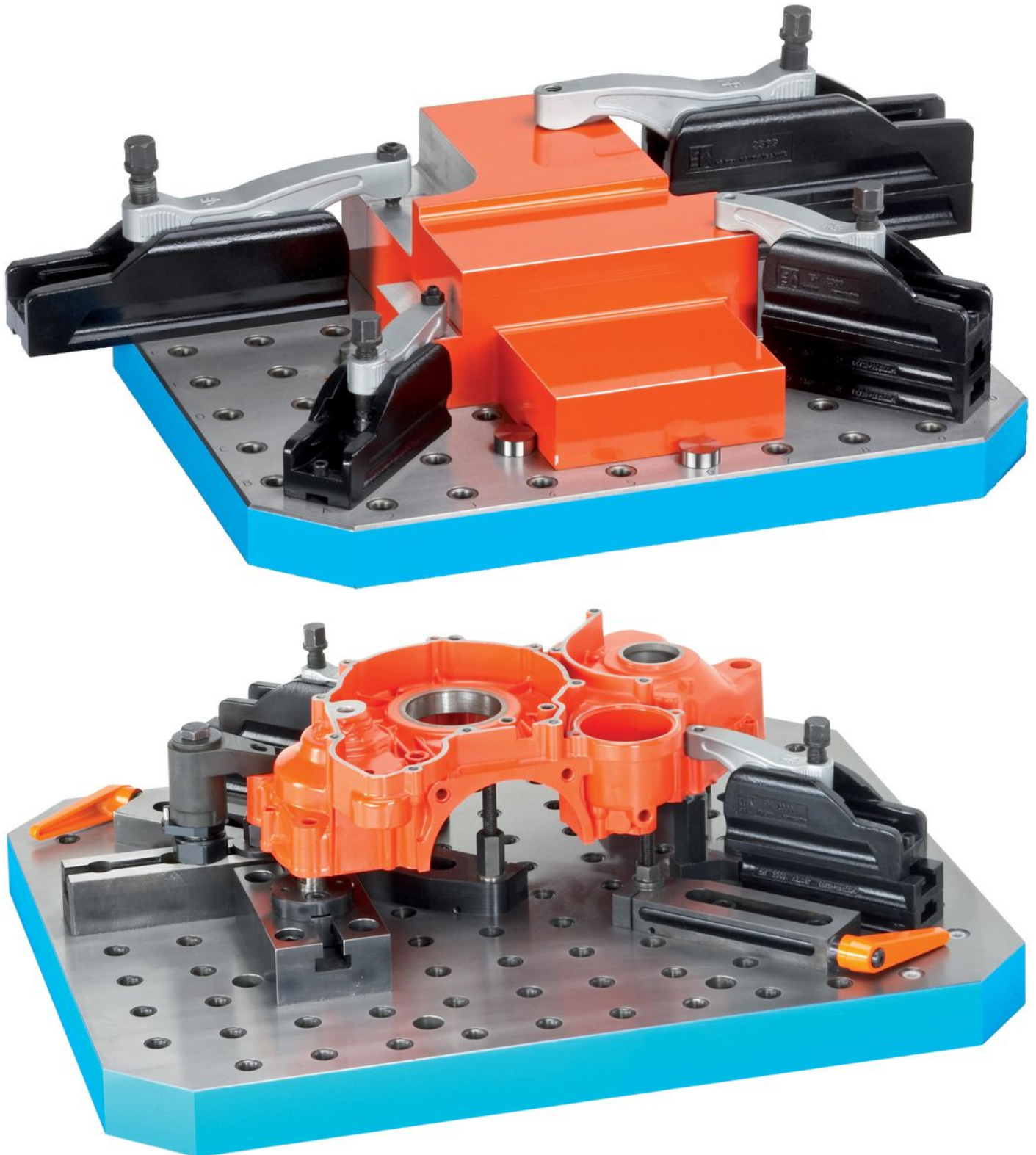

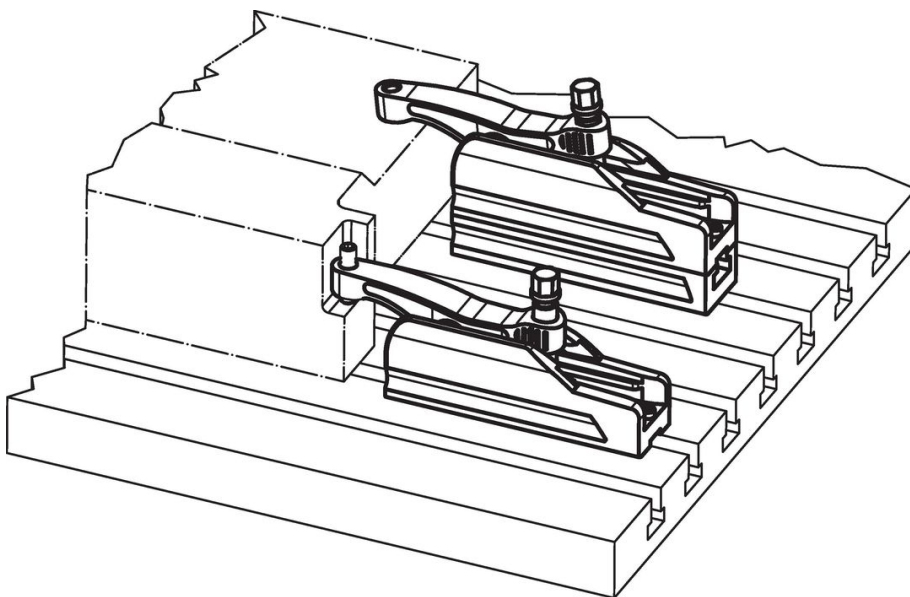
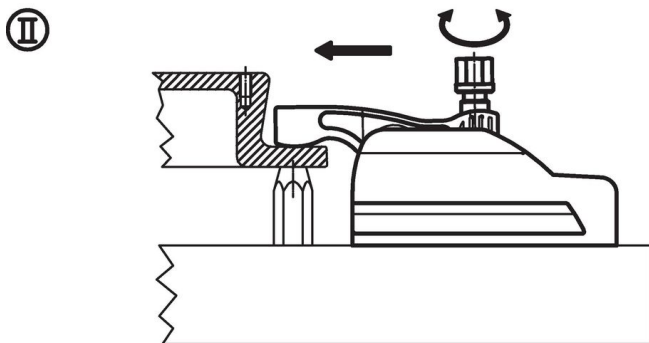
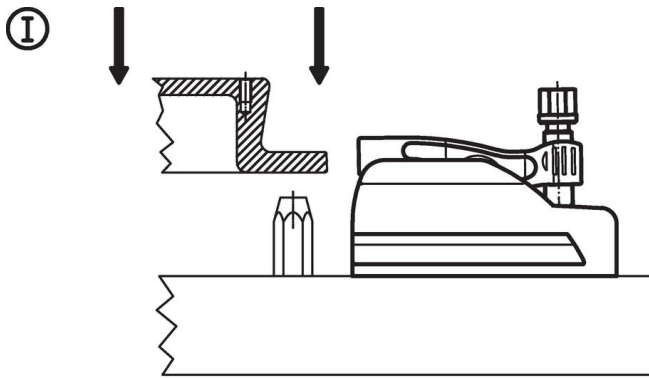

Compliance

RoHS compliant

Contains lead - compliant according to exceptions 6a / 6b / 6c.

Contains SVHC substances >0,1% w/w

Contains lead - SVHC list [REACH] as of 27.06.2024.

Contains Proposition 65 substances



Lead can cause cancer and reproductive harm from exposure
<https://www.P65Warnings.ca.gov/>

Free from Conflict Minerals

This product does not contain any substances designated as "conflict minerals" such as tantalum, tin, gold or tungsten from the Democratic Republic of Congo or adjacent countries.