

Vertical Toggle Clamps · with vertical base

EH 23330.



Product Description

Due to their favourable power to movement ratio and their easy action the toggle clamps are versatile applicable for a wide range of uses.

These toggle clamps can be used in the metal working industry when drilling, welding, bending, grinding, testing and fitting as well as in the wood and plastic industry in glueing, drilling, cutting and milling jigs.

The "toggle" principle of the toggle clamp allows a large and quick opening of the clamp. If unclamped the workpieces are completely cleared for unimpeded removal. The large power transmission results in maximum clamping force by low hand force. The clamps are self-arresting; they remain locked, resisting the force produced when machining components.

The toggle clamps are manufactured from high quality components and are designed for continuous use.

A oil resistant ergonomic 2-component handle, with increased grip area with soft surface for high ease of use.

The quickly adjustable clamping screws are provided by a retainer.

Material

Clamp

- Steel, zinc-plated by galvanization, passivated

Rivet

- Stainless steel

Handle

- plastic

Clamping screw

- Steel, tempered, zinc-plated by galvanization

Clamping cap

- Rubber, black

More information

References

Replacement clamping screws are available as accessories in the online shop.

Drawing

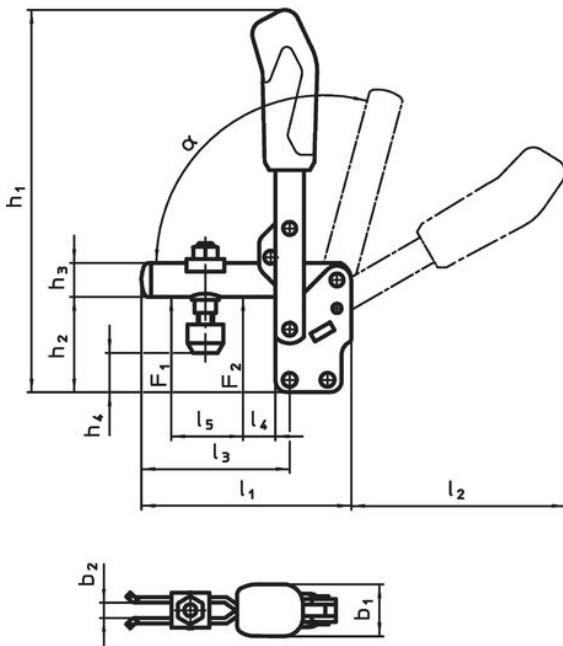

23330.0013

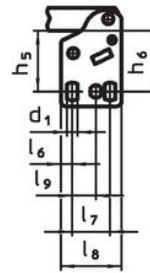

23330.0014

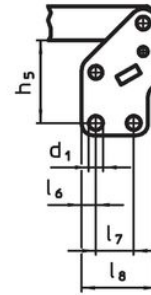

23330.0015

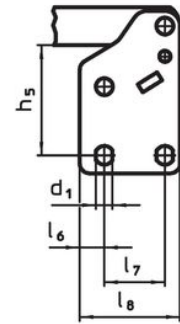

23330.0016

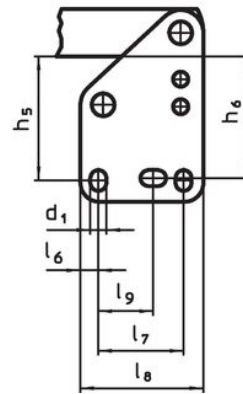

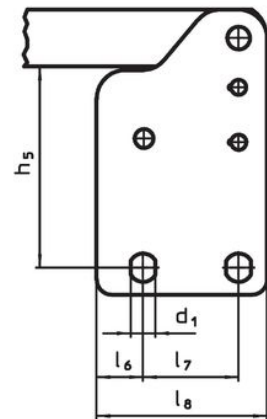

23330.0017



Order information

Nominal size	Clamping screw	Dimensions																			Holding force		α	min	max	Art. No.		
		d ₁	b ₁	b ₂	b ₃	h ₁	h ₂	h ₃	h ₄ min.	h ₄ max.	h ₅	h ₆	l ₁	l ₂	l ₃	l ₄	l ₅	l ₆	l ₇	l ₈	l ₉	F ₁					F ₂	[kN]
	[mm]	[mm]																			[kN]							
3	M 6 x 35	5.5	21	6	5	144.5	38	12	11.5	19.5	28.5 - 32	30	78	80	52	11	25	6.0	20.0	32	12.5	0.8	1.2	60°	-10	80	197	23330.0013
4	M 8 x 45	7.5	27	8	6	200.0	48	18	16.5	25.0	41.0	-	112	114	79	19	36	7.5	20.0	40	-	1.2	2.5	60°	-10	80	417	23330.0014
5	M 8 x 65	8.6	35	10	8	244.0	65	20	16.5	45.5	55.5	-	141	130	101	16	54	13.0	32.0	53	-	1.7	3.0	60°	-10	80	689	23330.0015
6	M12 x 80	8.5	36	14	10	301.0	77	25	18.0	49.0	66.0	64	195	183	140	35	72	9.5	45.0	65	26.5 - 31.5	3.0	5.0	60°	-10	80	1511	23330.0016
7	M12 x 110	13.0	39	14	10	369.0	117	30	33.0	90.5	102.0	-	231	206	165	28	89	24.5	50.5	90	-	3.4	5.5	60°	-10	80	2000	23330.0017

Accessories

	d ₂ [mm]	 [g]	Art. No.
Clamping screw (spare part of toggle clamp)			
	M 6 x 35	16	23330.9003
	M 8 x 45	38	23330.9005
	M 8 x 65	57	23330.9006
	M12 x 80	147	23330.9007
	M12 x 110	170	23330.9008

Compliance

For detailed compliance information please select the desired article number.