

Support Legs · impact cushioning

EH 22594.



Product Description

The support legs are universally usable as adjustable legs. These support legs with a rubber foot have a damping, noise-reducing effect, and prevent damage to the support surface.

Material

Body

- NBR

Screw

- Steel, zinc-plated by galvanization

Disc

- Steel, zinc-plated by galvanization

More information

Further products

- Rubber Endstop Buffers, cylindrical
- Rubber Endstop Buffers, parabolic
- Rubber Endstop Buffers, truncated cone form

Drawing

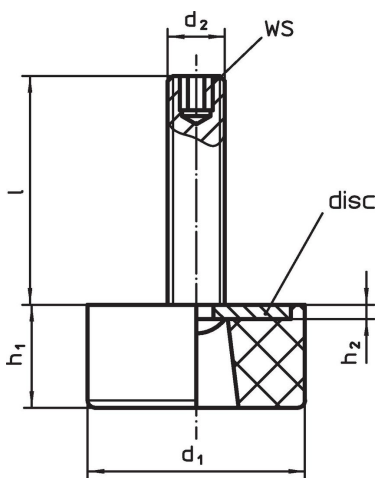

Order information

d ₁	l	Dimensions				WS	Load capacity for static load max. [N]	Temperature		Weight [g]	Art. No.
		d ₂	h ₁	h ₂	min.			max.			
[mm]							[°C]				
19	30	M 6	14	1.5	3	240	-30	120	12	22594.0005	
19	45	M 6	14	1.5	3	240	-30	120	14	22594.0010	
25	30	M 6	16	1.5	3	540	-30	120	18	22594.0015	
25	45	M 6	16	1.5	3	540	-30	120	21	22594.0020	
32	40	M 8	18	2.0	4	840	-30	120	37	22594.0025	
32	65	M 8	18	2.0	4	840	-30	120	44	22594.0030	
38	40	M 8	20	2.0	4	920	-30	120	50	22594.0035	
38	65	M 8	20	2.0	4	920	-30	120	58	22594.0040	
50	45	M10	22	2.5	5	2500	-30	120	98	22594.0045	
50	70	M10	22	2.5	5	2500	-30	120	111	22594.0050	
64	45	M10	26	2.5	5	3700	-30	120	165	22594.0055	
64	70	M10	26	2.5	5	3700	-30	120	177	22594.0060	

Compliance

RoHS compliant

Contains lead - compliant according to exceptions 6a / 6b / 6c.

Contains SVHC substances >0,1% w/w

Contains lead - SVHC list [REACH] as of 27.06.2024.

Contains Proposition 65 substances



Lead can cause cancer and reproductive harm from exposure
<https://www.P65Warnings.ca.gov/>

Free from Conflict Minerals

This product does not contain any substances designated as "conflict minerals" such as tantalum, tin, gold or tungsten from the Democratic Republic of Congo or adjacent countries.