

Clamping Angles

EH 1511.500 - EH 1611.500



Product Description

Material

- Grey cast iron, phosphatized

Drawing

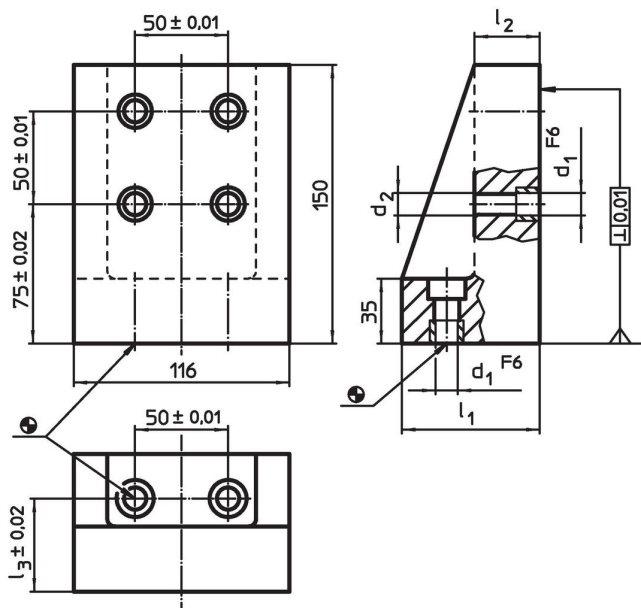

Order information

System	Dimensions					[kg]	Art. No.
	l_1	l_2	l_3 [mm]	d_1	d_2		
L12	74	35	50	12	M12	6	1511.500
L16	79	40	55	16	M16	6	1611.500

Application example

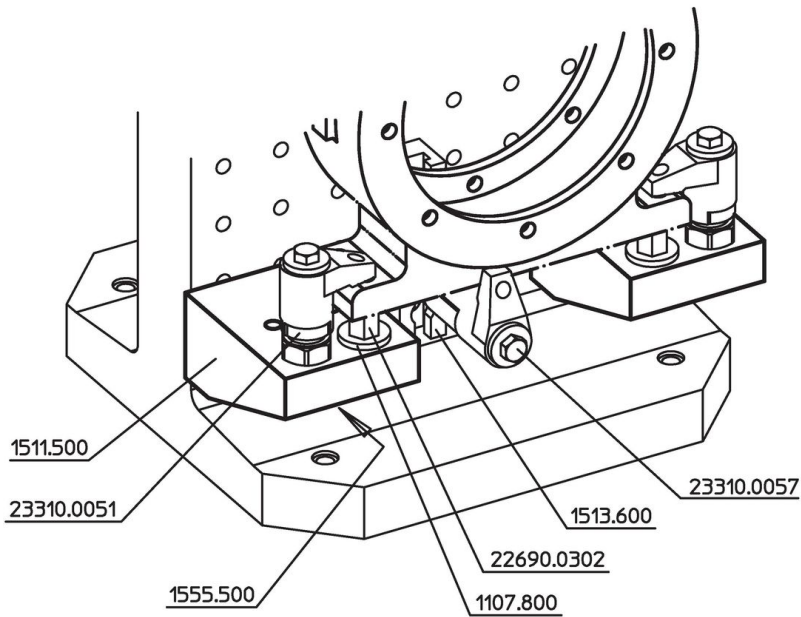

Compliance

RoHS compliant

Compliant according to Directive 2011/65/EU and Directive 2015/863.

Does not contain SVHC substances

No SVHC substances with more than 0.1% w/w contained - SVHC list [REACH] as of 27.06.2024.

Does not contain Proposition 65 substances

No Proposition 65 substances included.

<https://www.P65Warnings.ca.gov/>

Free from Conflict Minerals

This product does not contain any substances designated as "conflict minerals" such as tantalum, tin, gold or tungsten from the Democratic Republic of Congo or adjacent countries.