

Intermediate Elements

EH 1112.600 - EH 1112.800



Product Description

Material

- Steel, case-hardened, ground

Drawing

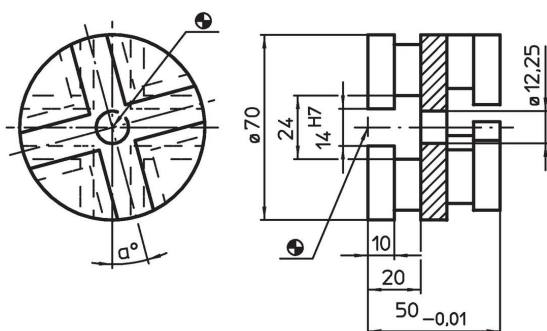

Order information

System	α	 [g]	Art. No.
V70	15°	800	1112.600
V70	30°	804	1112.700
V70	45°	789	1112.800

Compliance

RoHS compliant

Compliant according to Directive 2011/65/EU and Directive 2015/863.

Does not contain SVHC substances

No SVHC substances with more than 0.1% w/w contained - SVHC list [REACH] as of 23.01.2024.

Does not contain Proposition 65 substances

No Proposition 65 substances included.

<https://www.P65Warnings.ca.gov/>

Free from Conflict Minerals

This product does not contain any substances designated as "conflict minerals" such as tantalum, tin, gold or tungsten from the Democratic Republic of Congo or adjacent countries.