

## Lateral Plungers • smooth, with seal, with female thread - INCH

2B150.1126



### Product Description

To be used for positioning and applying pressure, e.g. during painting and sandblasting. Sealed against chips and dirt.

### Material

#### Seal

- CR

#### Body

- Aluminium Al

#### Threaded washer

- Steel, blackened

#### Spring

- Steel, blackened

### Assembly

Formula for calculating the center distance for the mounting hole:

$$l_0 = z/2 + w + x,$$

$l_0$  = center distance,

$y$  = workpiece height,

$w$  = workpiece length,

$x$  = stroke,

$z$  = stop diameter

Calculation dimension  $x$  for workpieces:

$$x = d_2/2 - s$$

Installation by pressing in.

### Characteristic

Version standard spring load = spring from steel, blackened

### More information

### Notes

Individual set screws can be screwed in the plate with threaded hole.

### Further products

- Eccentric Mounting Bushings, for lateral plungers, smooth - INCH

### Drawing

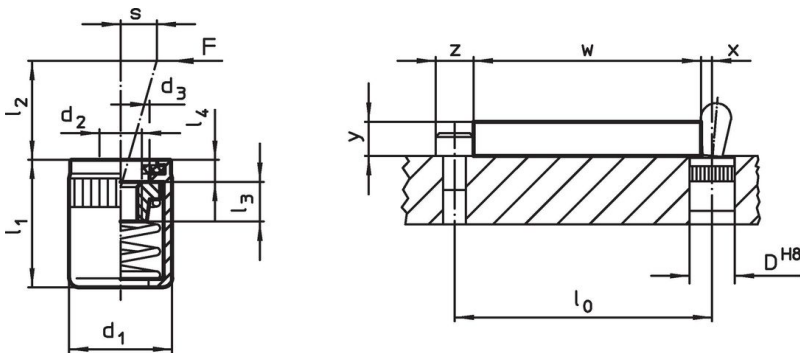

### Order information

Dimensions		Spring load F max. <sup>1)</sup>	Dimensions					Stroke s	Location hole D H8	max. [°F]	oz	Art. No.
d <sub>1</sub>	d <sub>2</sub>		d <sub>3</sub>	l <sub>1</sub>	l <sub>2</sub>	l <sub>3</sub>	l <sub>4</sub>					
[in]	[in]	[lb]	[mm]	[in]	[in]	[in]	[in]	[in]	[°F]	[oz]		
7/16	#8-32	16.9	0.248	0.43	0.295	0.177	0.063	0.079	7/16	230	0.094	2B150.1126

<sup>1)</sup> statistical average value

Accessories

	Dimensions d <sub>1</sub> [in]	 [oz]	Art. No.
<b>assembly tool</b>			
	7/16	1.749	22150.0831

Compliance

**RoHS compliant**

Compliant according to Directive 2011/65/EU and Directive 2015/863.

**Does not contain SVHC substances**

No SVHC substances with more than 0.1% w/w contained - SVHC list [REACH] as of 27.06.2024.

**Does not contain Proposition 65 substances**

No Proposition 65 substances included.

<https://www.P65Warnings.ca.gov/>

**Free from Conflict Minerals**

This product does not contain any substances designated as "conflict minerals" such as tantalum, tin, gold or tungsten from the Democratic Republic of Congo or adjacent countries.