

Spring Plungers · with ball and slot - INCH

2B050.0331



Product Description

To be used for positioning, indexing, locking, latching as well as for other similar pressure applications.
Spring plungers can be used for locating or for applying pressure, as a detent or for ejection.

Material

Body

- Stainless steel 1.4305 (ASTM-A-582)

Ball

- Stainless steel, hardened

Spring

- Stainless steel

Characteristic

Standard spring load: no marking



Light spring load



Standard spring load



Heavy spring load

More information

Notes

Special types on request.
Spring plungers are specially tested for spring range and forces.

- This product is manufactured in INCH dimensions.

References

A conversion table can be found in the technical data following these product information pages.

Thread lock: polyamide spot coating (for details please refer to the technical appendix).
Calculation of indexing resistance, please refer to appendix - Technical Data -

Further products

- Spring Plungers, with ball and slot
- Locators, with bore hole, for spring plungers
- Locators, smooth, for spring plungers

Drawing

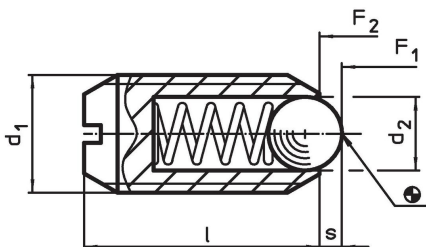

Order information

Dimensions				Stroke s	Spring load ¹⁾		Temperature		oz	Art. No.	
d ₁	Thread	d ₂	l		F ₁ ~	F ₂ ~	min.	max.			
[in]		[in]		[in]	[lb]		[°F]				
stainless steel, standard spring load, With thread lock											
#4-48	0.112	2A-UNF	1/16	3/16	0.02	0.1	0.5	-22	194	0.005	2B050.0331

¹⁾ statistical average value

Application example

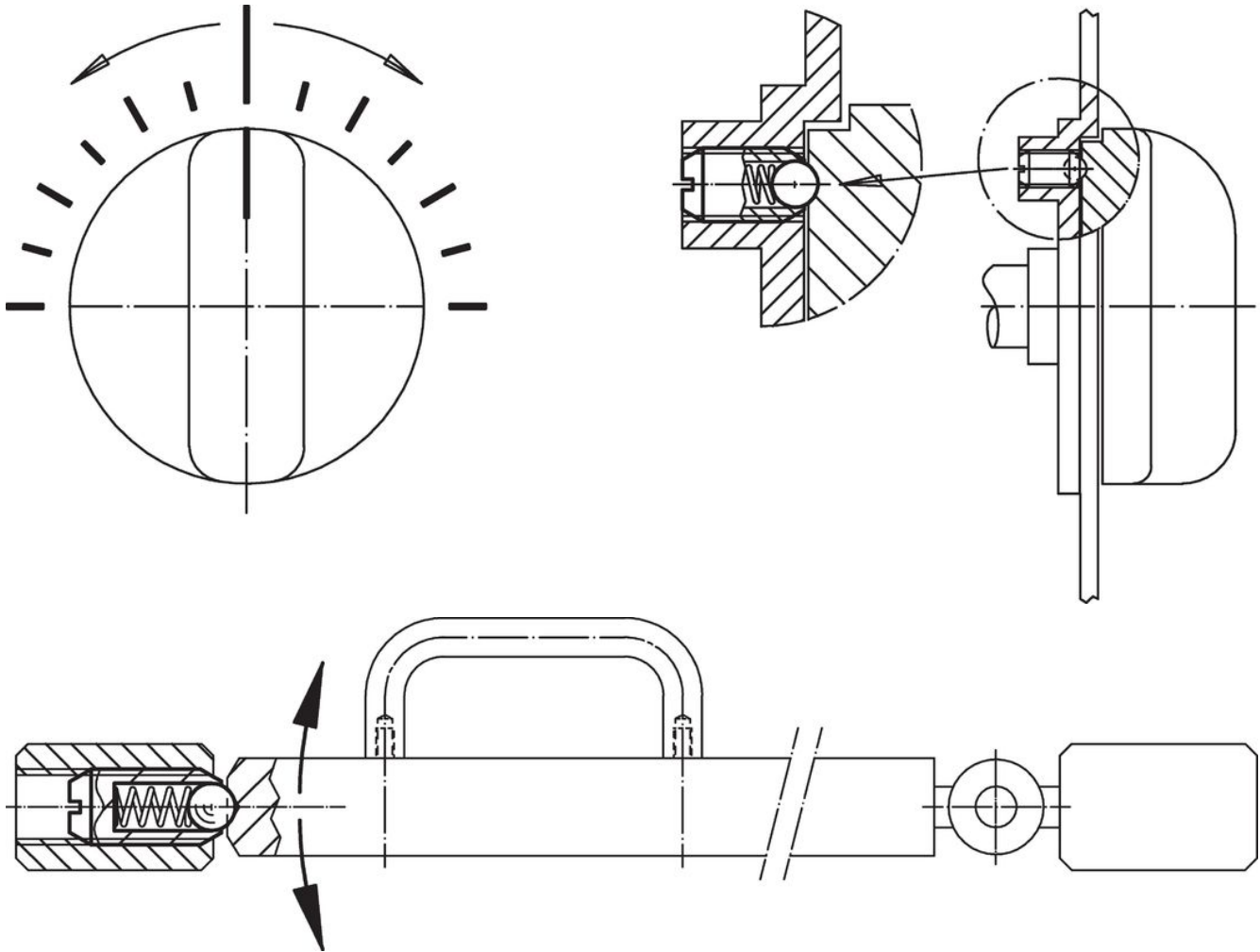

Compliance

RoHS compliant

Compliant according to Directive 2011/65/EU and Directive 2015/863.

Does not contain SVHC substances

No SVHC substances with more than 0.1% w/w contained - SVHC list [REACH] as of 27.06.2024.

Does not contain Proposition 65 substances

No Proposition 65 substances included.

<https://www.P65Warnings.ca.gov/>

Free from Conflict Minerals

This product does not contain any substances designated as "conflict minerals" such as tantalum, tin, gold or tungsten from the Democratic Republic of Congo or adjacent countries.