

Hinges • long version  
25165.0265



**Product Description**

The different versions cover many applications that require a low load. These metal hinges are characterised by their simple design and the different versions:

- without bores
- with bores
- with bores for countersunk screws

The version without bores can be assembled by welding or by inserting a specific drilling pattern.

**Material**

**Body**

- Stainless steel 1.4301

**Axis**

- Stainless steel 1.4301

**Drawing**

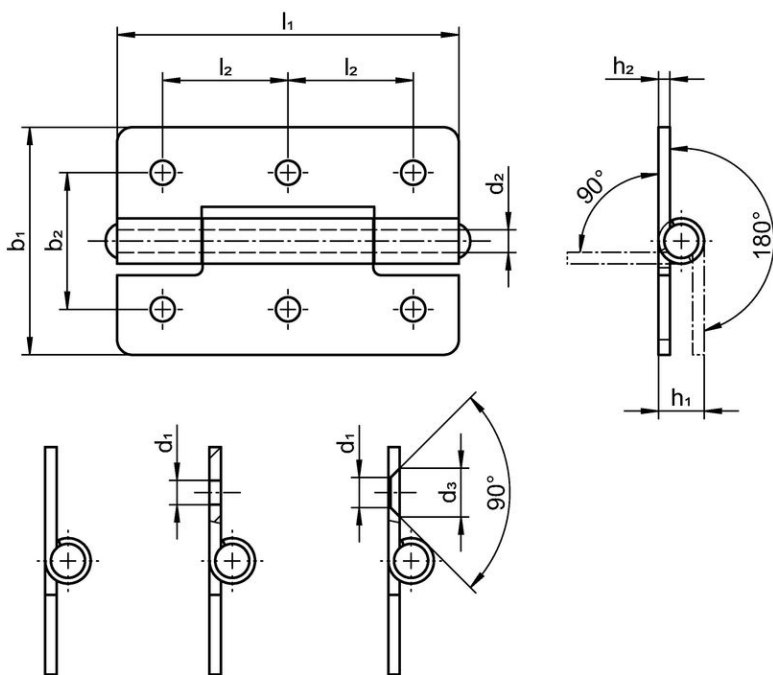

picture 1    picture 2    picture 3

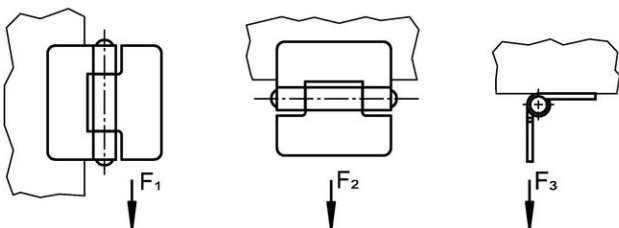

Order information

Dimensions										Holding force				Art. No.
b <sub>1</sub>	l <sub>1</sub>	b <sub>2</sub>	d <sub>1</sub>	d <sub>2</sub>	d <sub>3</sub>	h <sub>1</sub> ~	h <sub>2</sub>	l <sub>2</sub>	F <sub>1</sub> ~	F <sub>2</sub> ~	F <sub>3</sub> ~	[g]		
[mm]										[N]				
with bores for countersunk screws – picture 3, Stainless steel														
60	90	36	5	6	8.3	10	2	33	3000	3000	1200	121	25165.0265	

Compliance

**RoHS compliant**

Compliant according to Directive 2011/65/EU and Directive 2015/863.

**Does not contain SVHC substances**

No SVHC substances with more than 0.1% w/w contained - SVHC list [REACH] as of 23.01.2024.

**Does not contain Proposition 65 substances**

No Proposition 65 substances included.

<https://www.P65Warnings.ca.gov/>

**Free from Conflict Minerals**

This product does not contain any substances designated as "conflict minerals" such as tantalum, tin, gold or tungsten from the Democratic Republic of Congo or adjacent countries.