

Rubber Metal Buffers • waisted

25151.0106



Product Description

To be used for elastic bearing of motors, compressors, pumps etc.
The waisted shape of these buffers means that the lateral forces are better damped compared to cylindrical rubber-metal buffers.
The hardness is $55 \pm 5^\circ$ shore A. Further shore hardnesses ($40 \pm 5^\circ$ shore A and $70 \pm 5^\circ$ shore A) on request.

Material

Support washer

- Steel, zinc-plated by galvanization, passivated

Threaded bushing

- Steel, zinc-plated by galvanization, passivated

Body

- Rubber natural caoutchouc (NR), black

Screw

- Steel, zinc-plated by galvanization, passivated

More information

Notes

Under compressive load, the dimension d_3 does not exceed the diameter d_1 .

Drawing

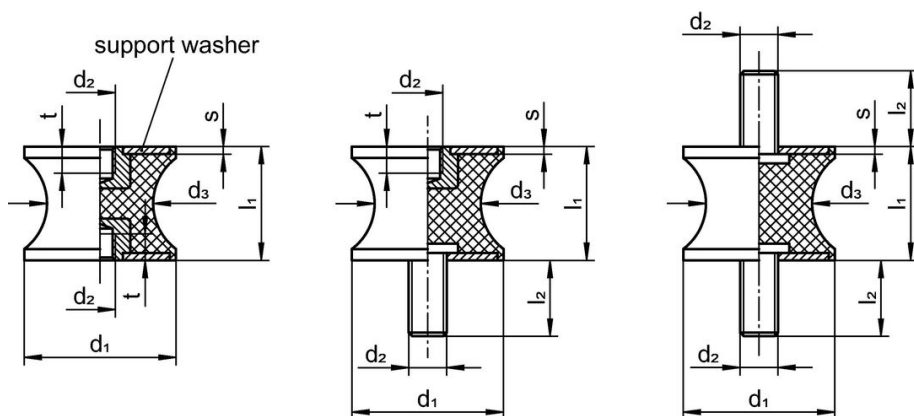

picture 1

picture 2

picture 3

Order information

Dimensions							Spring rate R	Load capacity max.	Spring range	Temperature range		Weight	Art. No.
d_1	l_1	d_2	d_3	l_2	s	t	[N/mm]	[N]	[mm]	min.	max.	[g]	
[mm]										[°C]			
with female thread and screw – picture 2													
10	10	M4	8	10	1	4	35	88	2.5	-30	80	3	25151.0106

Compliance

RoHS compliant

Compliant according to Directive 2011/65/EU and Directive 2015/863.

Does not contain SVHC substances

No SVHC substances with more than 0.1% w/w contained - SVHC list [REACH] as of 23.01.2024.

Does not contain Proposition 65 substances

No Proposition 65 substances included.

<https://www.P65Warnings.ca.gov/>

Free from Conflict Minerals

This product does not contain any substances designated as "conflict minerals" such as tantalum, tin, gold or tungsten from the Democratic Republic of Congo or adjacent countries.