

Rubber Endstop Buffers • truncated cone form

25150.0820



Product Description

To be used as an elastic end-stop, bearing foot etc.
The hardness is $55 \pm 5^\circ$ shore A. Further shore hardnesses ($40 \pm 5^\circ$ shore A and $70 \pm 5^\circ$ shore A) on request.

Material

Support washer

- Steel, zinc-plated by galvanization, passivated

Body

- NBR

Screw

- Steel, zinc-plated by galvanization, passivated

More information

Further products

- Support Legs, impact cushioning
- Silicone Endstop Buffers, truncated cone form

Drawing

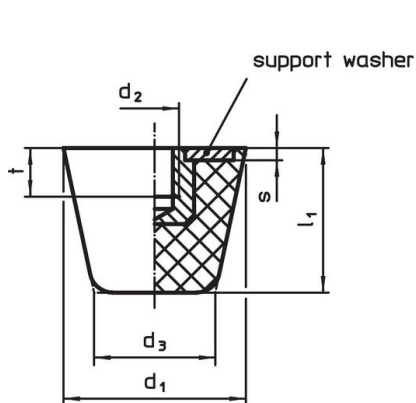

picture 1

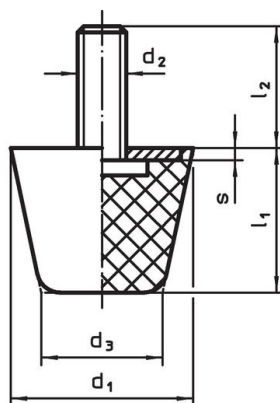

picture 2

Order information

Dimensions						Spring rate R ~ [N/mm]	Load capacity max. [N]	Spring range ~ [mm]	Temperature		Weight [g]	Art. No.
d ₁	d ₂	l ₂	d ₃	l ₁	s				min.	max.		
with screw – picture 2, Steel												
19	M5	10	12	16	2	28	110	4	-30	80	6.1	25150.0820

Compliance

RoHS compliant

Contains lead - compliant according to exceptions 6a / 6b / 6c.

Contains SVHC substances >0,1% w/w

Contains lead - SVHC list [REACH] as of 27.06.2024.

Contains Proposition 65 substances



Lead can cause cancer and reproductive harm from exposure
<https://www.P65Warnings.ca.gov/>

Free from Conflict Minerals

This product does not contain any substances designated as "conflict minerals" such as tantalum, tin, gold or tungsten from the Democratic Republic of Congo or adjacent countries.