

Rubber Metal Buffers • cylindrical

25150.0123



Product Description

To be used for elastic bearing of motors, compressors, pumps etc.
The hardness is $55 \pm 5^\circ$ shore A. Further shore hardnesses ($40 \pm 5^\circ$ shore A and $70 \pm 5^\circ$ shore A) on request.

Material

Support washer

- Steel, zinc-plated, blue chromated

Threaded bushing

- Steel, zinc-plated, blue chromated

Body

- Rubber natural caoutchouc (NR), black

Screw

- Steel, zinc-plated, blue chromated

Drawing

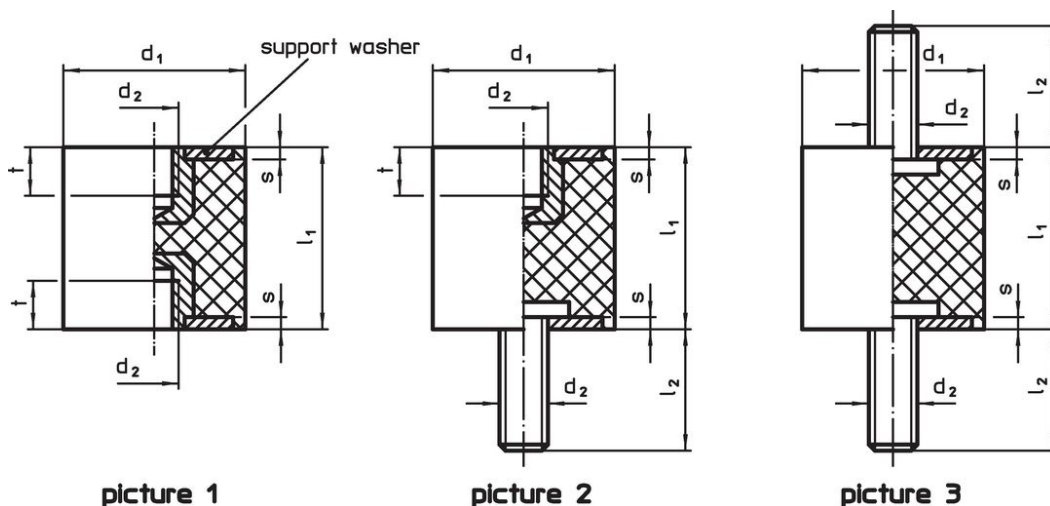

Order information

Dimensions						Spring rate R	Load capacity max.	Spring range	Temperature		Weight	Art. No.
d ₁	l ₁	d ₂	l ₂	s	t	~		~	min.	max.	[g]	
[mm]						[N/mm]	[N]	[mm]	[°C]			
±1.5	±1.5				~							
with female thread and screw – picture 2												
20	25	M6	18	2	5	50	315	6.25	-30	80	18	25150.0123

Application example





Compliance

RoHS compliant

Contains lead - compliant according to exceptions 6a / 6b / 6c.

Contains SVHC substances >0,1% w/w

Contains lead - SVHC list [REACH] as of 27.06.2024.

Contains Proposition 65 substances



Lead can cause cancer and reproductive harm from exposure
<https://www.P65Warnings.ca.gov/>

Free from Conflict Minerals

This product does not contain any substances designated as "conflict minerals" such as tantalum, tin, gold or tungsten from the Democratic Republic of Congo or adjacent countries.