

Quick Plug Couplings · with angular and radial offset compensation

25100.0430



Product Description

Quick plug coupling, adjustable without axial play, including angular and radial offset compensation. Suitable for multiple applications, e.g. for non-aligned linear movements. Solid and compact design, no loose elements.

Material

Claw

- Heat-treated steel, tempered, phosphated

Seat

- Heat-treated steel, tempered, phosphated

Coupling part

- Heat-treated steel, nitrided, black

Nut

- Heat-treated steel, phosphated

Lock nut

- Steel, black (ISO 4035/8675)

Spring

- Stainless steel

Assembly

Assembly and disassembly is by means of a T-slot; a manual re-adjustment is not necessary.

The quick plug coupling can be linked to all commonly used pneumatic and hydraulic lifting cylinders via the connecting thread.

More information

Notes

The quick plug coupling does not transmit any torque.

Drawing



Order information

d ₁	d ₂	d ₃	Dimensions						WS				Radial offset compensation x max. [mm]	Maximum tensile and compressive load max. [kN]	[g]	Art. No.
			l ₁	l ₂	l ₃	l ₄ min.	l ₅	l ₆	WS ₁	WS ₂	WS ₃	WS ₄				
M10 x 1,25	44	21	81	22	16	24	43	30.5	41	36	18	12	0.7	6.5	396	25100.0430

Application example

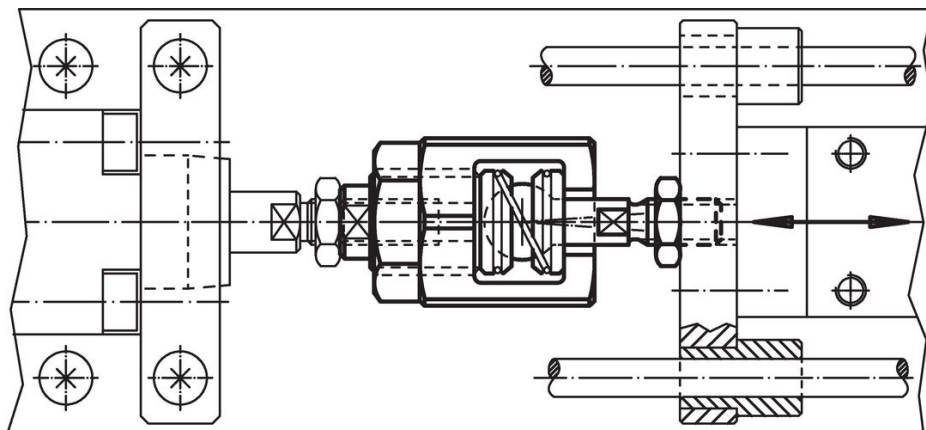

Compliance

RoHS compliant

Contains lead - compliant according to exceptions 6a / 6b / 6c.

Contains SVHC substances >0,1% w/w

Contains lead - SVHC list [REACH] as of 23.01.2024.

Contains Proposition 65 substances



Lead can cause cancer and reproductive harm from exposure
<https://www.P65Warnings.ca.gov/>

Free from Conflict Minerals

This product does not contain any substances designated as "conflict minerals" such as tantalum, tin, gold or tungsten from the Democratic Republic of Congo or adjacent countries.