

Set Collars
25069.0340



Product Description

Set collars with universal applicability, e.g. as a fixed stop.
Set collars with strong clamping force.

Material

Screw

- Stainless steel

Set collar

- Stainless steel 1.4404

Drawing

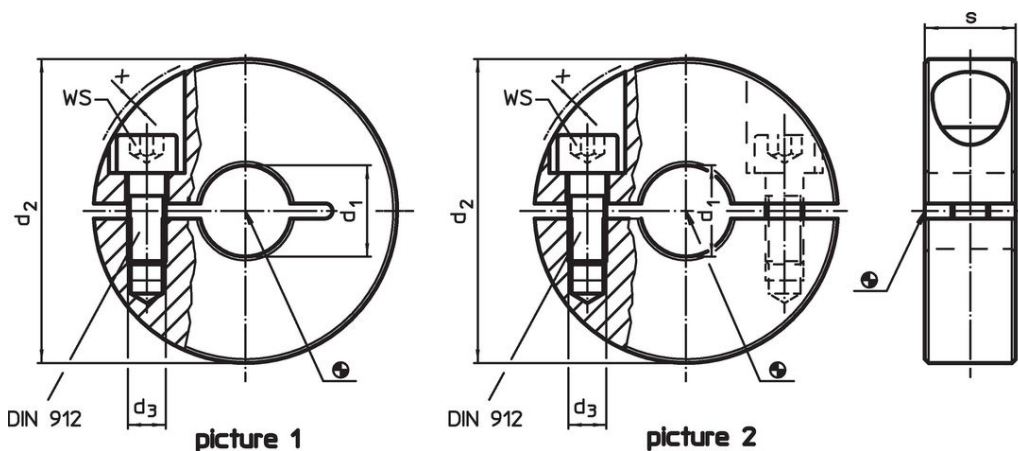

Order information

d ₁ H10	d ₂	Dimensions			WS [mm]	[g]	Art. No.
		d ₃ [mm]	s	x			
divided – picture 2, Stainless steel							
40	65	M6	15	0.5	5	189	25069.0340

Application example



Compliance

RoHS compliant

Compliant according to Directive 2011/65/EU and Directive 2015/863.

Does not contain SVHC substances

No SVHC substances with more than 0.1% w/w contained - SVHC list [REACH] as of 23.01.2024.

Does not contain Proposition 65 substances

No Proposition 65 substances included.

<https://www.P65Warnings.ca.gov/>

Free from Conflict Minerals

This product does not contain any substances designated as "conflict minerals" such as tantalum, tin, gold or tungsten from the Democratic Republic of Congo or adjacent countries.