

Set Collars

25069.0214



Product Description

Set collars with universal applicability, e.g. as a fixed stop.
Set collars with strong clamping force.

Material

Screw

- Steel

Set collar

- Steel, black, steam oxidized

Drawing

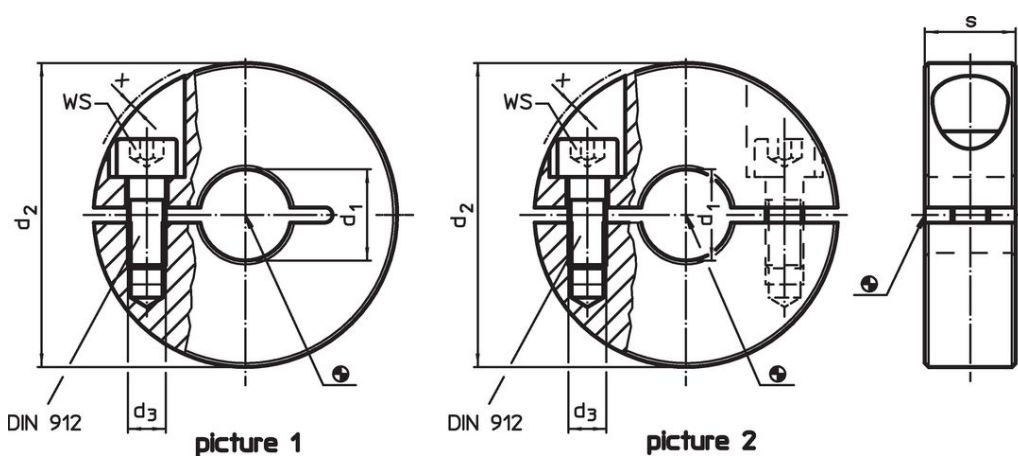

Order information

d ₁ H10	d ₂	Dimensions			WS [mm]	[g]	Art. No.
		d ₃ [mm]	s	x			
divided – picture 2, Steel							
14	32	M4	11	0.7	3	43	25069.0214

Application example



Compliance

RoHS compliant

Contains lead - compliant according to exceptions 6a / 6b / 6c.

Contains SVHC substances >0,1% w/w

Contains lead - SVHC list [REACH] as of 23.01.2024.

Contains Proposition 65 substances



Lead can cause cancer and reproductive harm from exposure
<https://www.P65Warnings.ca.gov/>

Free from Conflict Minerals

This product does not contain any substances designated as "conflict minerals" such as tantalum, tin, gold or tungsten from the Democratic Republic of Congo or adjacent countries.