

## Tapered Shaft Hubs · without lock nut

25050.0018

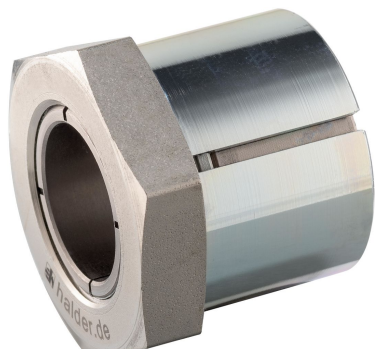

### Product Description

By using tapered shaft hubs, all shaft-hub joints of machine elements such as sprocket wheels, gear wheels, belt pulleys, cams, levers etc. can be easily and efficiently established. It is a self-centering and non-floating tapered shaft hub in corrosion-protected design with a hexagon nut. The rotational accuracy of the tapered shaft hubs is 0,03 mm.

### Material

#### External part

- Steel, zinc-plated by galvanization

#### Inner part

- Steel, nickel-plated

#### Nut

- Steel, nickel-plated

### More information

### References

Comply with mounting instructions, mounting examples, and technical data.

### Drawing

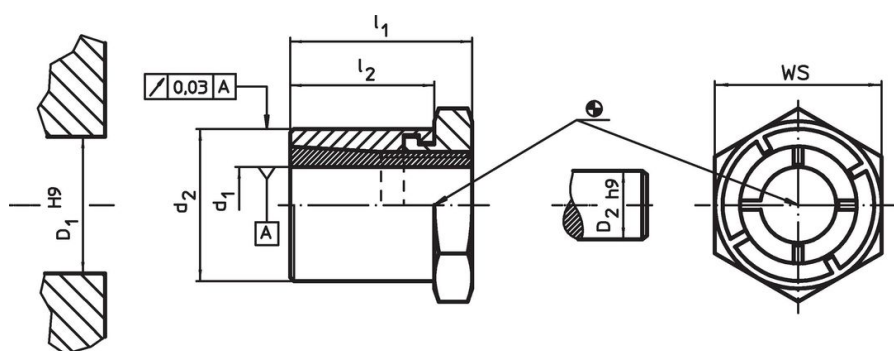

### Order information

Dimensions				WS	Tightening torque of the nut $T_A$ max.	Transferable torque $M$ max.	Transferable axial load $F_a$ max.	Surface pressure of shaft $p_w$ max.	Surface pressure of hub $p_N$ max.	Hub bore $D_1$ H9	Shaft diameter $D_2$ h9	[g]	Art. No.
$d_1$	$d_2$	$l_1$	$l_2$										
18	35	36	27	36	161	223	24.8	224	125	35	18	197	25050.0018

### Accessories

	WS		Art. No.
	[mm]	[g]	
<b>special fork wrench</b>			
	36	428	25050.0836

### Application example



### Compliance

#### RoHS compliant

Compliant according to Directive 2011/65/EU and Directive 2015/863.

#### Does not contain SVHC substances

No SVHC substances with more than 0.1% w/w contained - SVHC list [REACH] as of 23.01.2024.

#### Does not contain Proposition 65 substances

No Proposition 65 substances included.

<https://www.P65Warnings.ca.gov/>

#### Free from Conflict Minerals

This product does not contain any substances designated as "conflict minerals" such as tantalum, tin, gold or tungsten from the Democratic Republic of Congo or adjacent countries.