

Tapered Shaft Hubs · without lock nut

25050.0006



Product Description

By using tapered shaft hubs, all shaft-hub joints of machine elements such as sprocket wheels, gear wheels, belt pulleys, cams, levers etc. can be easily and efficiently established. It is a self-centering and non-floating tapered shaft hub in corrosion-protected design with a hexagon nut. The rotational accuracy of the tapered shaft hubs is 0,03 mm.

Material

External part

- Steel, zinc-plated by galvanization

Inner part

- Steel, nickel-plated

Nut

- Steel, nickel-plated

More information

References

Comply with mounting instructions, mounting examples, and technical data.

Drawing

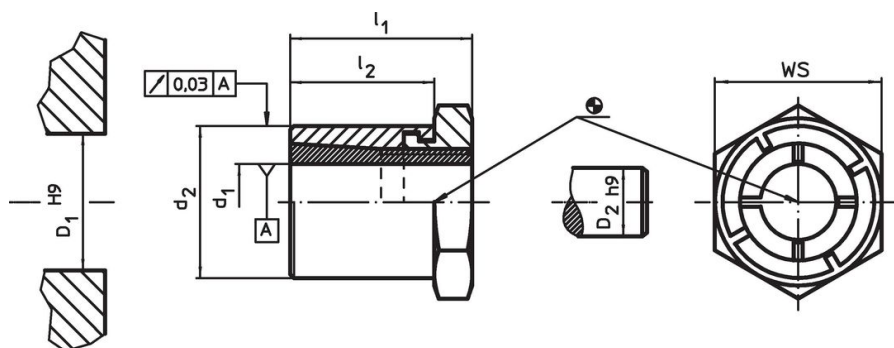

Order information

Dimensions		WS	Tightening torque of the nut T_A max.	Transferable torque M max.	Transferable axial load F_a max.	Surface pressure of shaft p_w max.	Surface pressure of hub p_N max.	Hub bore D_1 H9	Shaft diameter D_2 h9	Art. No.			
d_1	d_2										l_1	l_2	[mm]
6	14	19	15	14	9.9	12.1	4	220	96	14	6	17	25050.0006

Accessories

	WS [mm]	Art. No.
special fork wrench		
	14	25050.0814

Application example

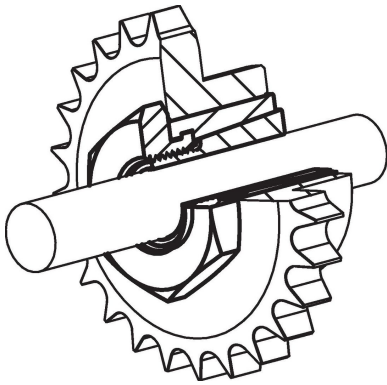

Compliance

RoHS compliant

Compliant according to Directive 2011/65/EU and Directive 2015/863.

Does not contain SVHC substances

No SVHC substances with more than 0.1% w/w contained - SVHC list [REACH] as of 23.01.2024.

Does not contain Proposition 65 substances

No Proposition 65 substances included.

<https://www.P65Warnings.ca.gov/>

Free from Conflict Minerals

This product does not contain any substances designated as "conflict minerals" such as tantalum, tin, gold or tungsten from the Democratic Republic of Congo or adjacent countries.