

Knurled Thumb Screws • plastic

24830.0050



Product Description

Material

Handle

- Thermoplastic PA, black

Screw

- Steel, zinc-plated by galvanization

Drawing

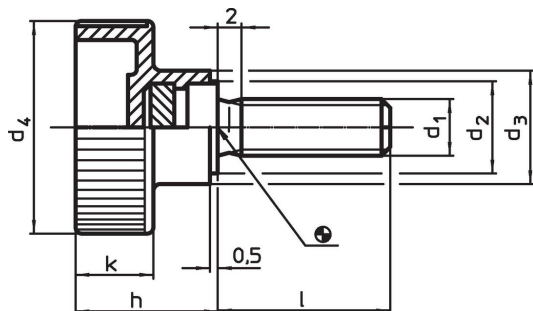

Order information

Dimensions							Temperature		Weight	Art. No.
d ₁	l	d ₂	d ₃	d ₄	h	k	min.	max.	[g]	
[mm]							[°C]			
Steel										
M6	10	12	14	24	16.5	9.5	-30	80	7	24830.0050

Application example

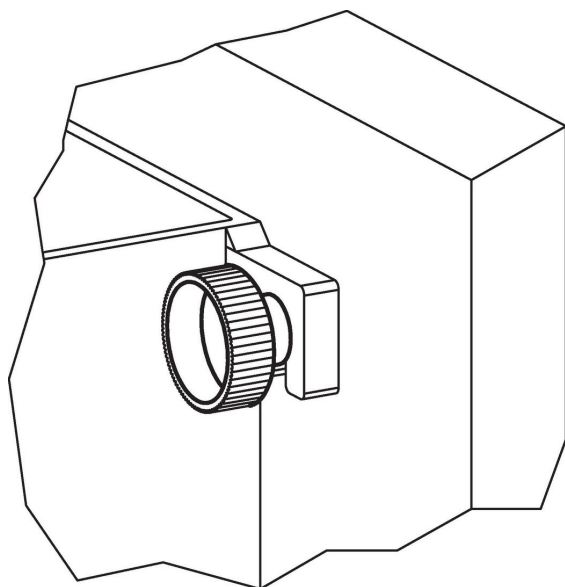

Compliance

RoHS compliant

Contains lead - compliant according to exceptions 6a / 6b / 6c.

Contains SVHC substances >0,1% w/w

Contains lead - SVHC list [REACH] as of 23.01.2024.

Contains Proposition 65 substances



Lead can cause cancer and reproductive harm from exposure
<https://www.P65Warnings.ca.gov/>

Free from Conflict Minerals

This product does not contain any substances designated as "conflict minerals" such as tantalum, tin, gold or tungsten from the Democratic Republic of Congo or adjacent countries.