

High Knurled Thumb Screws • DIN 464

24790.0358



Product Description

All knurled screws are one-piece manufactured. Contrary to the Official Standard Sheet, they all have a thread up to the head, but no recess at the thread end.

Material

- Stainless steel 1.4305, dull blasted

More information

Notes

Knurling pitch and knurling depth may differ from DIN.

Drawing



Order information

Dimensions							Art. No.
d_1	l	d_2	d_3	h	k	[g]	
Stainless steel							
M8	25	30	16	18	6	58	24790.0358

Application example

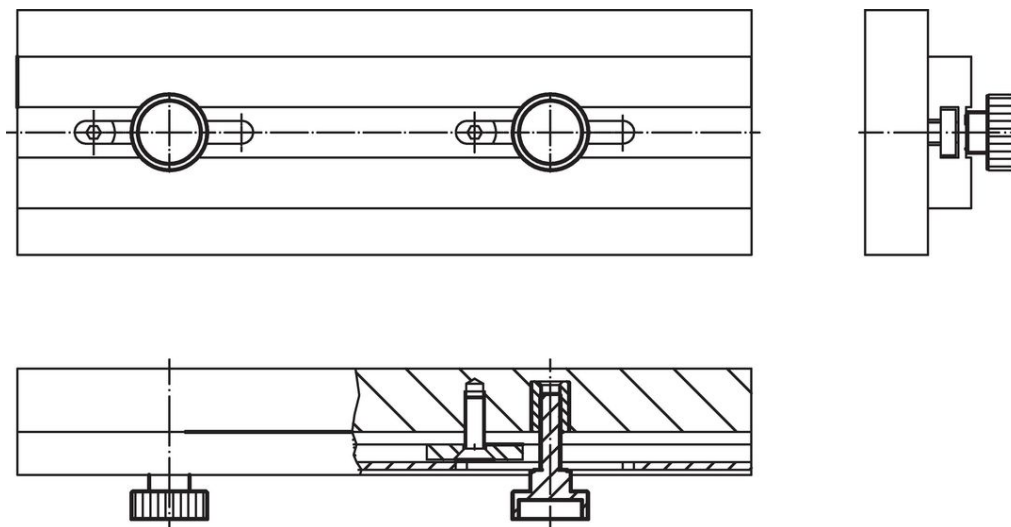

Compliance

RoHS compliant

Compliant according to Directive 2011/65/EU and Directive 2015/863.

Does not contain SVHC substances

No SVHC substances with more than 0.1% w/w contained - SVHC list [REACH] as of 23.01.2024.

Does not contain Proposition 65 substances

No Proposition 65 substances included.

<https://www.P65Warnings.ca.gov/>

Free from Conflict Minerals

This product does not contain any substances designated as "conflict minerals" such as tantalum, tin, gold or tungsten from the Democratic Republic of Congo or adjacent countries.