

High Knurled Nuts • DIN 466

24780.0060



Product Description

Knurled nuts are very versatile. Three material versions for the different requirements

- Steel, blackened
 - Steel, zinc-plated by galvanization
 - Stainless steel
- are available.

Knurled nuts can be easily tightened and released by hand. The ribbed outer surface of the nut prevents slipping when tightening / releasing with the fingers. The high knurled nuts are manufactured according to DIN 467.

Material

- Steel, blackened, quality 5

More information

Notes

Knurling pitch and knurling depth may differ from DIN.

Further products

- Flat Knurled Nuts, DIN 467

Drawing

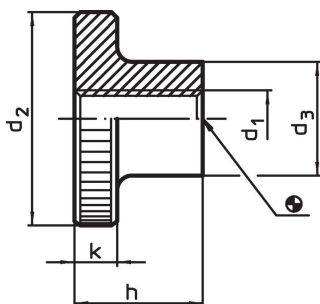

Order information

Dimensions					Art. No.
d ₁	d ₂	d ₃	h	k	
[mm]					[g]
Steel					
M6	24	12	15	5	23
					24780.0060

Application example

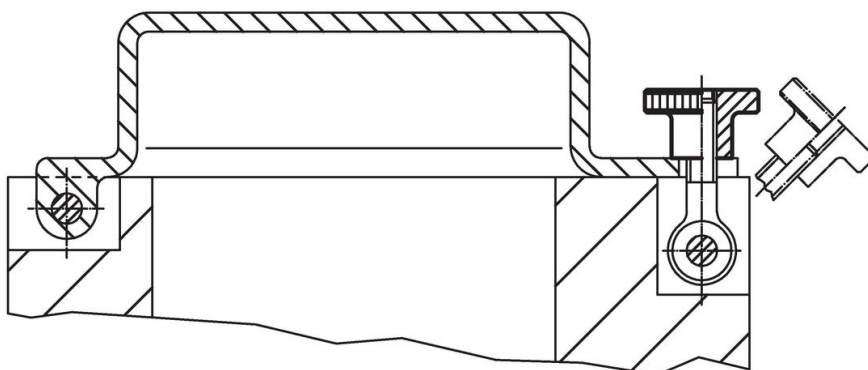

Compliance

RoHS compliant

Contains lead - compliant according to exceptions 6a / 6b / 6c.

Contains SVHC substances >0,1% w/w

Contains lead - SVHC list [REACH] as of 27.06.2024.

Contains Proposition 65 substances



Lead can cause cancer and reproductive harm from exposure
<https://www.P65Warnings.ca.gov/>

Free from Conflict Minerals

This product does not contain any substances designated as "conflict minerals" such as tantalum, tin, gold or tungsten from the Democratic Republic of Congo or adjacent countries.