

## Flat Knurled Thumb Screws • DIN 653

24770.0294



### Product Description

All knurled screws are one-piece manufactured with thread up to the head (DIN-designation A).

### Material

- Stainless steel 1.4305, dull blasted

### More information

### Notes

Knurling pitch and knurling depth may differ from DIN.

### Drawing

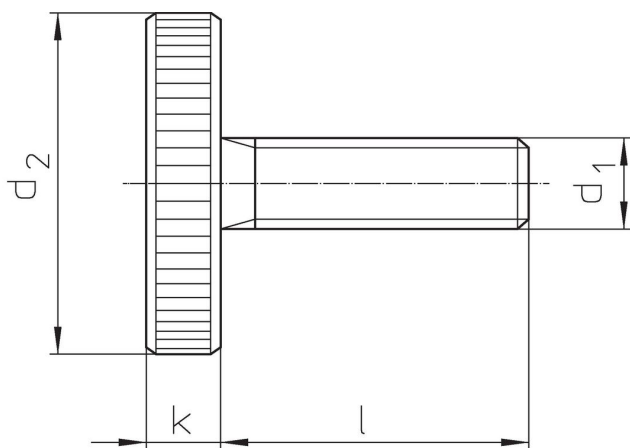

### Order information

		Dimensions			Art. No.
d <sub>1</sub>	l	d <sub>2</sub>	k	[g]	
[mm]					
Stainless steel					
M4	12	16	3.5	6.1	24770.0294

### Compliance

#### RoHS compliant

Compliant according to Directive 2011/65/EU and Directive 2015/863.

#### Does not contain SVHC substances

No SVHC substances with more than 0.1% w/w contained - SVHC list [REACH] as of 23.01.2024.

#### Does not contain Proposition 65 substances

No Proposition 65 substances included.

<https://www.P65Warnings.ca.gov/>

#### Free from Conflict Minerals

This product does not contain any substances designated as "conflict minerals" such as tantalum, tin, gold or tungsten from the Democratic Republic of Congo or adjacent countries.