

## Star Grip Screws • similar to DIN 6336, stainless steel A4

24741.0125



### Product Description

These star grip screws are manufactured according to DIN 6336, but it is a version without dirty edges. This makes these star grip screws suitable for all areas of application with high hygienic requirements. The stainless steel A4 version ensures maximum corrosion resistance.

### Material

#### Handle

- Stainless steel 1.4408, precision casting, polished

#### Screw

- Stainless steel A4

### Drawing

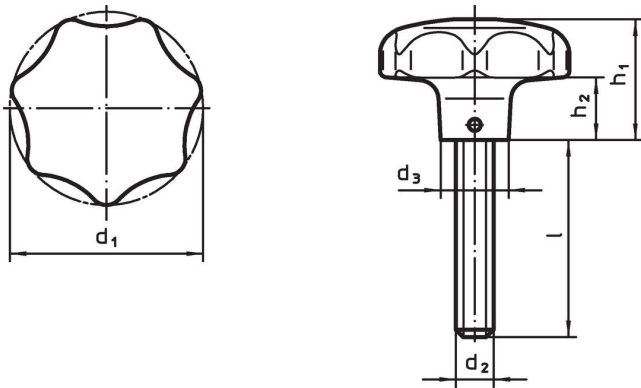

### Order information

d <sub>1</sub>	d <sub>2</sub>	Dimensions				h <sub>1</sub>	h <sub>2</sub>	[g]	Art. No.
		l	d <sub>3</sub>	[mm]					
50	M10	20	18			32	15	229	24741.0125

### Compliance

#### RoHS compliant

Compliant according to Directive 2011/65/EU and Directive 2015/863.

#### Does not contain SVHC substances

No SVHC substances with more than 0.1% w/w contained - SVHC list [REACH] as of 23.01.2024.

#### Does not contain Proposition 65 substances

No Proposition 65 substances included.  
<https://www.P65Warnings.ca.gov/>

#### Free from Conflict Minerals

This product does not contain any substances designated as "conflict minerals" such as tantalum, tin, gold or tungsten from the Democratic Republic of Congo or adjacent countries.