

Star Grips • stainless steel, solid
24690.0656



Product Description

Version without dirt trap. Convenient for all applications having high hygienic requirements (e.g. food industry).

Material

Handle

- Stainless steel 1.4305, dull blasted

Drawing

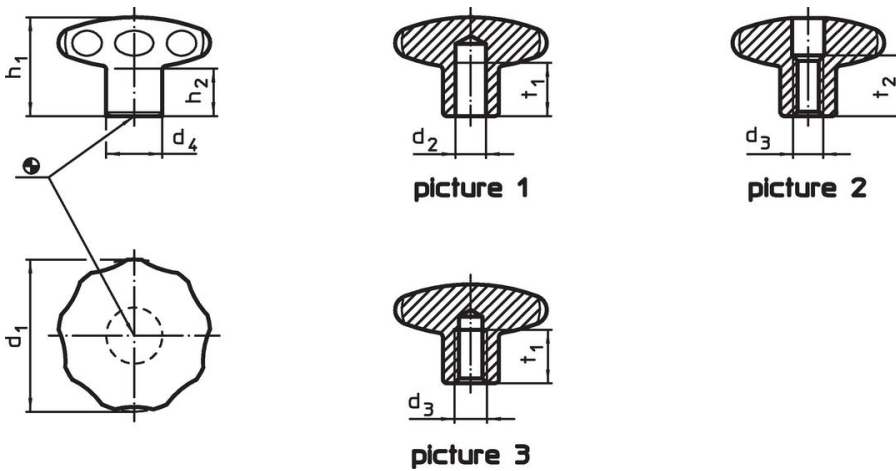

Order information

d ₁	d ₃	Dimensions				t ₁ min.	[g]	Art. No.
		d ₄	h ₁	h ₂	[mm]			
with threaded blind hole – picture 3								
50	M10	21	34	17	15	270	24690.0656	

Application example



Compliance

RoHS compliant

Compliant according to Directive 2011/65/EU and Directive 2015/863.

Does not contain SVHC substances

No SVHC substances with more than 0.1% w/w contained - SVHC list [REACH] as of 23.01.2024.

Does not contain Proposition 65 substances

No Proposition 65 substances included.

<https://www.P65Warnings.ca.gov/>

Free from Conflict Minerals

This product does not contain any substances designated as "conflict minerals" such as tantalum, tin, gold or tungsten from the Democratic Republic of Congo or adjacent countries.