

Star Grips • DIN 6336 plastic
24670.1263



Product Description

Material

Bushing

- Stainless steel A2

Handle

- DIN 7708 - thermosetting plastic (PF 31), black similar to RAL 9005

Drawing

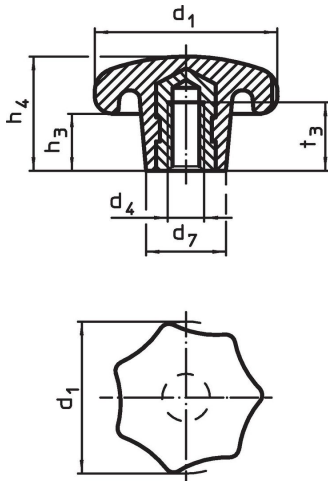

Order information

Dimensions						max. [°C]	[g]	Art. No.
d ₁	d ₄	d ₇	h ₃	h ₄	t ₃			
with threaded bushing, form K, Stainless steel								
63	M12	26	21	40	22	110	83	24670.1263

Application example

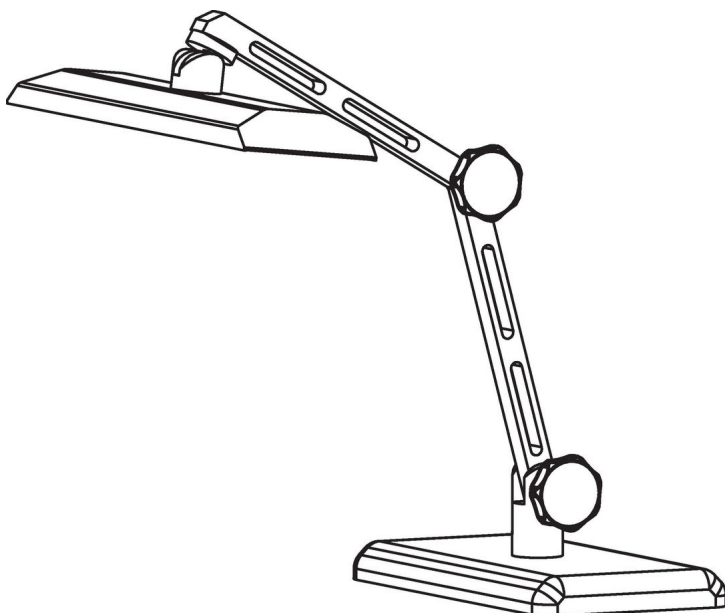

Compliance

RoHS compliant

Compliant according to Directive 2011/65/EU and Directive 2015/863.

Does not contain SVHC substances

No SVHC substances with more than 0.1% w/w contained - SVHC list [REACH] as of 23.01.2024.

Does not contain Proposition 65 substances

No Proposition 65 substances included.

<https://www.P65Warnings.ca.gov/>

Free from Conflict Minerals

This product does not contain any substances designated as "conflict minerals" such as tantalum, tin, gold or tungsten from the Democratic Republic of Congo or adjacent countries.