

**Palm Grips · DIN 6335 plastic**  
24640.0240



**Product Description**

**Material**

**Bushing**

- Steel, zinc-plated by galvanization

**Handle**

- DIN 7708 - thermosetting plastic (PF 31), black similar to RAL 9005

**Drawing**

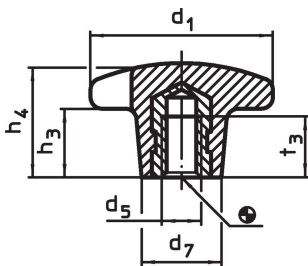

**Order information**

Dimensions						max. [°C]	[g]	Art. No.
d <sub>1</sub>	d <sub>5</sub>	d <sub>7</sub>	h <sub>3</sub>	h <sub>4</sub>	t <sub>3</sub>			
with threaded bushing, form K, Steel								
40	M8	18	13	25	14	110	16	24640.0240

**Application example**

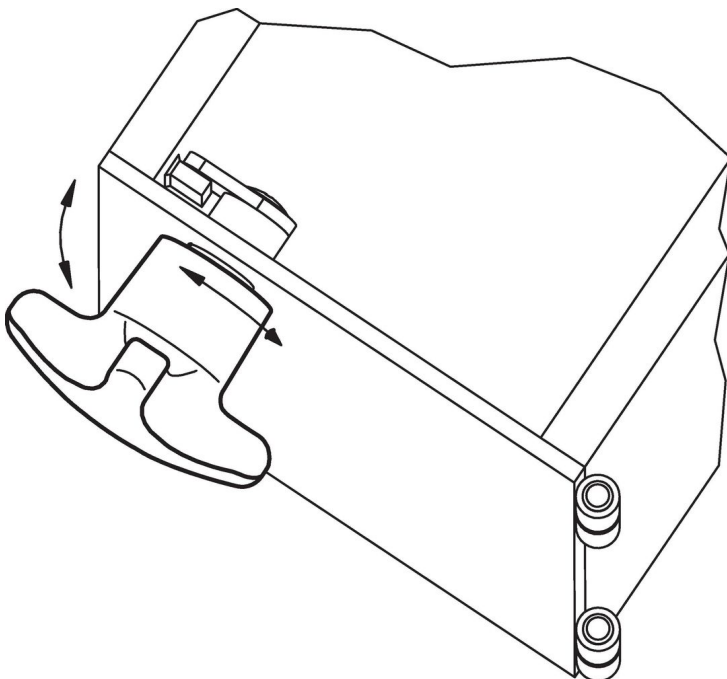

## Compliance

### RoHS compliant

Compliant according to Directive 2011/65/EU and Directive 2015/863.

### Does not contain SVHC substances

No SVHC substances with more than 0.1% w/w contained - SVHC list [REACH] as of 23.01.2024.

### Does not contain Proposition 65 substances

No Proposition 65 substances included.

<https://www.P65Warnings.ca.gov/>

### Free from Conflict Minerals

This product does not contain any substances designated as "conflict minerals" such as tantalum, tin, gold or tungsten from the Democratic Republic of Congo or adjacent countries.