

**Palm Grips • DIN 6335 stainless steel, die-cast**  
24631.0440



**Product Description**

These palm grips are manufactured according to DIN 6335.

**Material**

**Handle**

- Stainless steel A2, dull blasted

**Drawing**

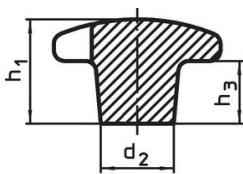

picture 1

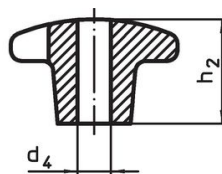

picture 2

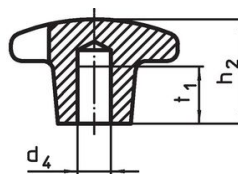

picture 3

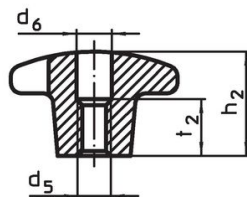
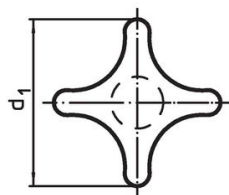

picture 4

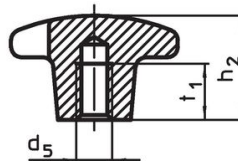

picture 5

**Order information**

d <sub>1</sub>	d <sub>2</sub>	Dimensions			[g]	Art. No.
		d <sub>5</sub>	h <sub>2</sub>	t <sub>1</sub> min.		
[mm]						
with threaded blind hole, form E – picture 5						
40	14	M8	25	15	70	24631.0440

**Application example**

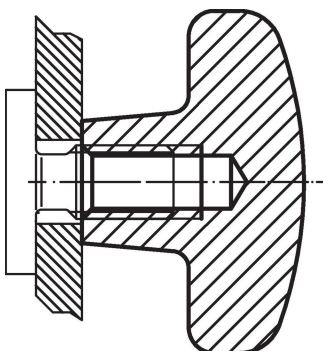

## Compliance

### RoHS compliant

Compliant according to Directive 2011/65/EU and Directive 2015/863.

### Does not contain SVHC substances

No SVHC substances with more than 0.1% w/w contained - SVHC list [REACH] as of 23.01.2024.

### Does not contain Proposition 65 substances

No Proposition 65 substances included.

<https://www.P65Warnings.ca.gov/>

### Free from Conflict Minerals

This product does not contain any substances designated as "conflict minerals" such as tantalum, tin, gold or tungsten from the Democratic Republic of Congo or adjacent countries.