

Ball Knobs • DIN 319

24560.0220



Product Description

The DIN 319 ball knobs are jointless and polished.

Material

Bushing

- Steel, zinc-plated by galvanization

Ball

- Thermosetting plastic PF 31, black similar to RAL 9005

Assembly

Assembly instruction for form M: Fitted by lightly tapping with a hammer, holds in position without being cemented. For the counter element a h9-fit is sufficient.

Drawing



Order information

Dimensions					For pin	🌡️	📦	Art. No.
d ₁	d ₃	d ₄	h	t ₃	h9	max.	[g]	
[mm]					[mm]	[°C]		
with taper bore form M – picture 3, black								
20	5	12	18	12	5	110	5.1	24560.0220

Application example

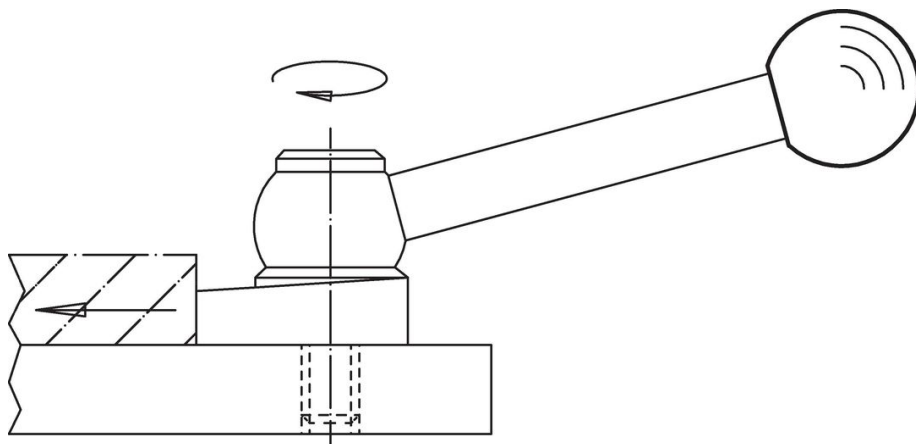

Compliance

RoHS compliant

Compliant according to Directive 2011/65/EU and Directive 2015/863.

Does not contain SVHC substances

No SVHC substances with more than 0.1% w/w contained - SVHC list [REACH] as of 27.06.2024.

Does not contain Proposition 65 substances

No Proposition 65 substances included.

<https://www.P65Warnings.ca.gov/>

Free from Conflict Minerals

This product does not contain any substances designated as "conflict minerals" such as tantalum, tin, gold or tungsten from the Democratic Republic of Congo or adjacent countries.