

Cylindrical Handles • rotating

24530.0031



Product Description

Material

Axle part

- Steel, zinc-plated by galvanization

Cylindrical handle

- Thermosetting plastic PF 31, black

Drawing

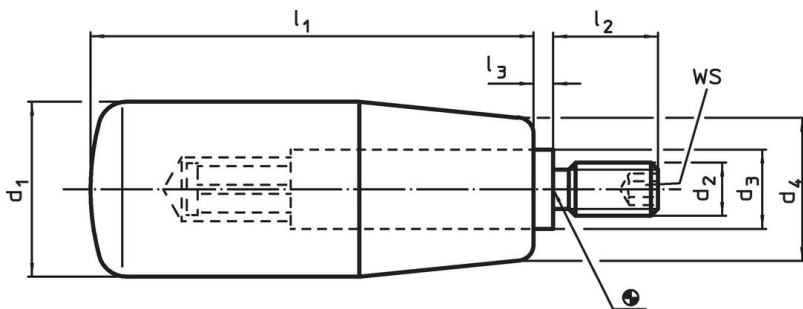

Order information

Dimensions							WS	🌡️	📦	Art. No.
d ₁	d ₂	d ₃	d ₄	l ₁	l ₂	l ₃	[mm]	max. [°C]	[g]	
Thermoset, Steel										
22	M8	10	18	56	13	2.5	4	110	48	24530.0031

Application example

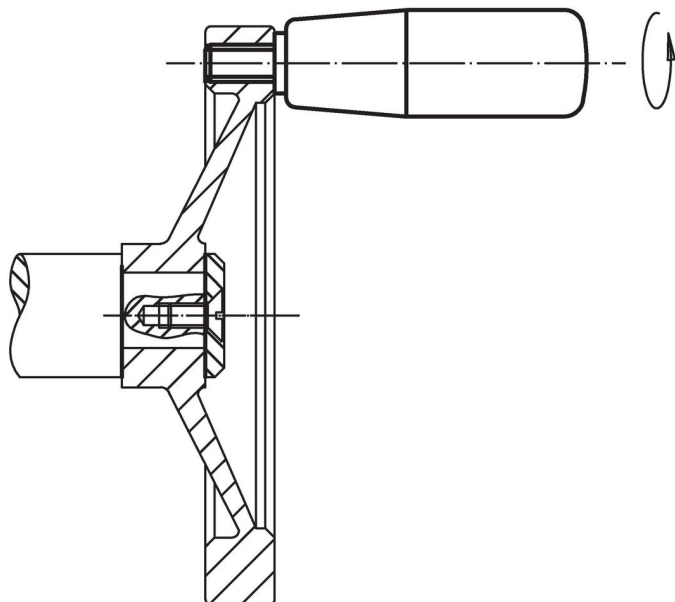

Compliance

RoHS compliant

Contains lead - compliant according to exceptions 6a / 6b / 6c.

Contains SVHC substances >0,1% w/w

Contains lead - SVHC list [REACH] as of 23.01.2024.

Contains Proposition 65 substances



Lead can cause cancer and reproductive harm from exposure

<https://www.P65Warnings.ca.gov/>

Free from Conflict Minerals

This product does not contain any substances designated as "conflict minerals" such as tantalum, tin, gold or tungsten from the Democratic Republic of Congo or adjacent countries.