

Knurled Nuts • DIN 6303

24480.0005



Product Description

Material

- Free cutting steel, blackened

Assembly

Form B: after being bored through the pin hole is to be situated within the tolerance field H7.

More information

Notes

Knurling pitch and knurling depth may differ from DIN.

Drawing

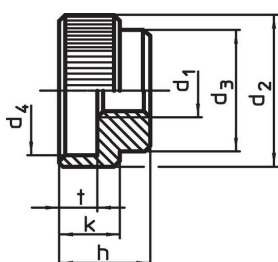

picture 1

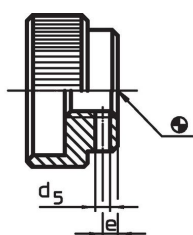

picture 2

Order information

Dimensions							[g]	Art. No.
d ₁	d ₂	d ₃	d ₄	h	k	t		
without pin hole, form A – picture 1, Free cutting steel								
M5	20	14	15	12	8	5	16	24480.0005

Application example

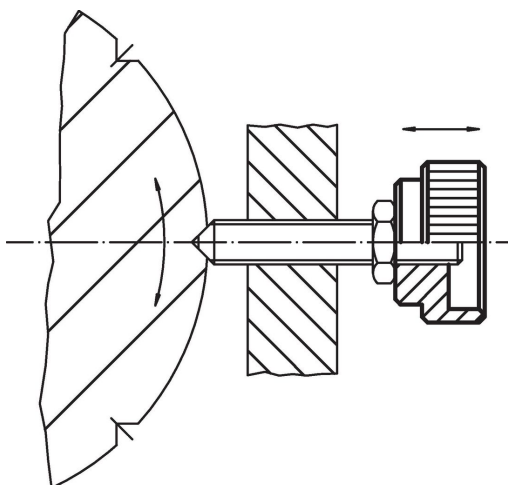

Compliance

RoHS compliant

Contains lead - compliant according to exceptions 6a / 6b / 6c.

Contains SVHC substances >0,1% w/w

Contains lead - SVHC list [REACH] as of 27.06.2024.

Contains Proposition 65 substances



Lead can cause cancer and reproductive harm from exposure
<https://www.P65Warnings.ca.gov/>

Free from Conflict Minerals

This product does not contain any substances designated as "conflict minerals" such as tantalum, tin, gold or tungsten from the Democratic Republic of Congo or adjacent countries.