

Clamping Nuts · welded

24470.0512



Product Description

Low-price version to DIN 99.

Material

- Steel, zinc-plated by galvanization

Drawing

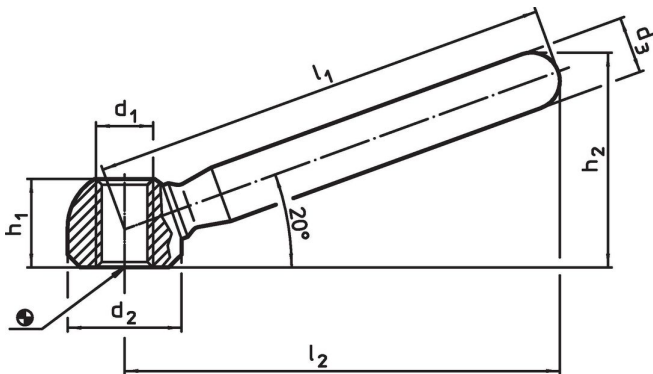

Order information

Dimensions							Art. No.		
l_1	l_2	d_1	d_2	d_3	h_1	h_2			
[mm]							[g]		
Steel	125	119	M16	32	18	25	58.5	313	24470.0512

Application example



Compliance

RoHS compliant

Contains lead - compliant according to exceptions 6a / 6b / 6c.

Contains SVHC substances >0,1% w/w

Contains lead - SVHC list [REACH] as of 23.01.2024.

Contains Proposition 65 substances



Lead can cause cancer and reproductive harm from exposure
<https://www.P65Warnings.ca.gov/>

Free from Conflict Minerals

This product does not contain any substances designated as "conflict minerals" such as tantalum, tin, gold or tungsten from the Democratic Republic of Congo or adjacent countries.