

Tapered Levers • DIN 99

24470.0406



Product Description

Material

- Stainless steel 1.4305, dull blasted

Drawing

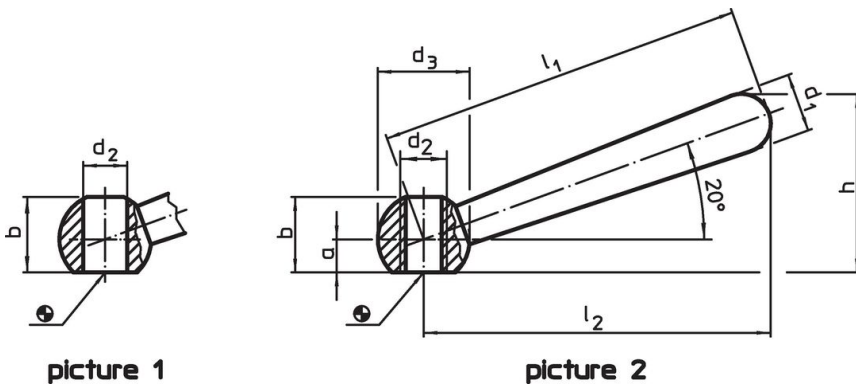

Order information

Dimensions								[g]	Art. No.
l_1	l_2 ~	a	b ~	d_1 [mm]	d_2	d_3	h ~		
slanted, with thread, form N – picture 2, Stainless steel									
63	60	5	12.5	10	M8	16	30.5	38	24470.0406

Application example



Compliance

RoHS compliant

Compliant according to Directive 2011/65/EU and Directive 2015/863.

Does not contain SVHC substances

No SVHC substances with more than 0.1% w/w contained - SVHC list [REACH] as of 27.06.2024.

Does not contain Proposition 65 substances

No Proposition 65 substances included.

<https://www.P65Warnings.ca.gov/>

Free from Conflict Minerals

This product does not contain any substances designated as "conflict minerals" such as tantalum, tin, gold or tungsten from the Democratic Republic of Congo or adjacent countries.