

## Adjustable Tension Levers

24440.0132



### Product Description

#### Material

##### Lever

- Steel, blackened

##### Inner parts

- Steel, blackened, quality 5.8

##### Screw

- Steel, blackened, quality 5.8

##### Ball knob

- Thermosetting plastic PF 31, black, DIN 319

#### Operation

**By lifting the lever** the serrations are disengaged. The lever can be positioned by the serrations. On releasing the lever, the serrations are automatically re-engaged.

#### More information

#### Notes

The threaded portion can be exchanged.

### Drawing

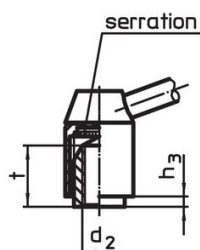
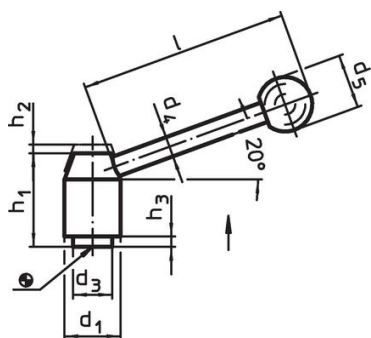

picture 1

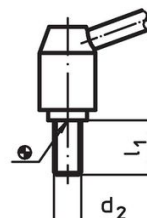

picture 2

### Order information

d <sub>1</sub>	d <sub>2</sub>	l <sub>1</sub>	d <sub>3</sub>	Dimensions				h <sub>1</sub>	h <sub>2</sub>	h <sub>3</sub>	l	[g]	Art. No.
				d <sub>4</sub>	d <sub>5</sub>	[mm]							
<b>with screw – picture 2, Steel</b>													
21	M8	50	13.5	8	20			33.5	4	1	70	109	24440.0132

### Compliance

#### RoHS compliant

Contains lead - compliant according to exceptions 6a / 6b / 6c.

#### Contains SVHC substances >0,1% w/w

Contains lead - SVHC list [REACH] as of 23.01.2024.

#### Contains Proposition 65 substances



Lead can cause cancer and reproductive harm from exposure  
<https://www.P65Warnings.ca.gov/>

#### Free from Conflict Minerals

This product does not contain any substances designated as "conflict minerals" such as tantalum, tin, gold or tungsten from the Democratic Republic of Congo or adjacent countries.