

Tension Levers

24430.0050



Product Description

Material

Lever

- Steel, blackened

Ball knob

- Thermosetting plastic PF 31, black, DIN 319

Drawing

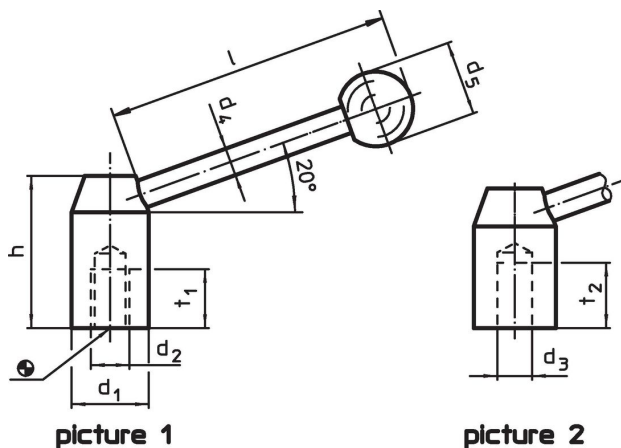

Order information

Dimensions							[g]	Art. No.
d ₁	d ₃ H7	d ₄	d ₅	h	l	t ₂		
[mm]								
with smooth bore – picture 2, Steel								
36	16	14	35	58	138	28	524	24430.0050

Application example

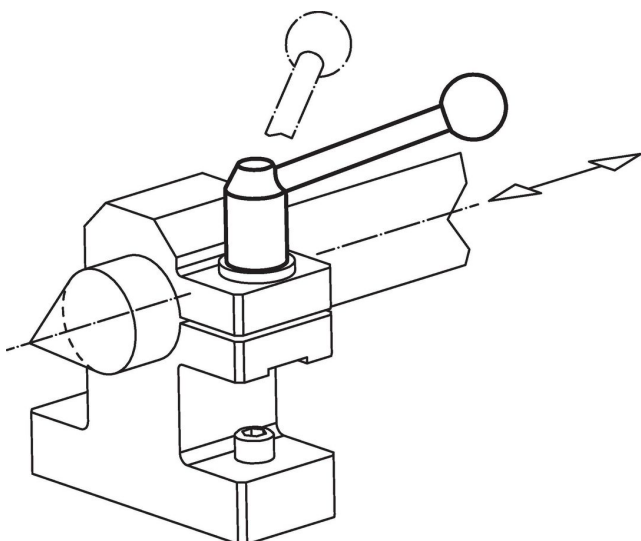

Compliance

RoHS compliant

Contains lead - compliant according to exceptions 6a / 6b / 6c.

Contains SVHC substances >0,1% w/w

Contains lead - SVHC list [REACH] as of 27.06.2024.

Contains Proposition 65 substances



Lead can cause cancer and reproductive harm from exposure
<https://www.P65Warnings.ca.gov/>

Free from Conflict Minerals

This product does not contain any substances designated as "conflict minerals" such as tantalum, tin, gold or tungsten from the Democratic Republic of Congo or adjacent countries.