

## Tension Levers

24430.0040



### Product Description

#### Material

##### Lever

- Steel, blackened

##### Ball knob

- Thermosetting plastic PF 31, black, DIN 319

### Drawing

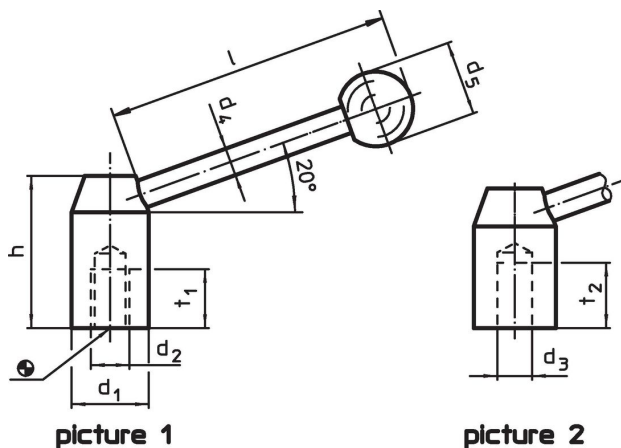

### Order information

Dimensions							[g]	Art. No.
d <sub>1</sub>	d <sub>3</sub> H7	d <sub>4</sub>	d <sub>5</sub> [mm]	h	l ~	t <sub>2</sub>		
with smooth bore – picture 2, Steel								
28	12	12	30	47	108	23	268	24430.0040

### Application example

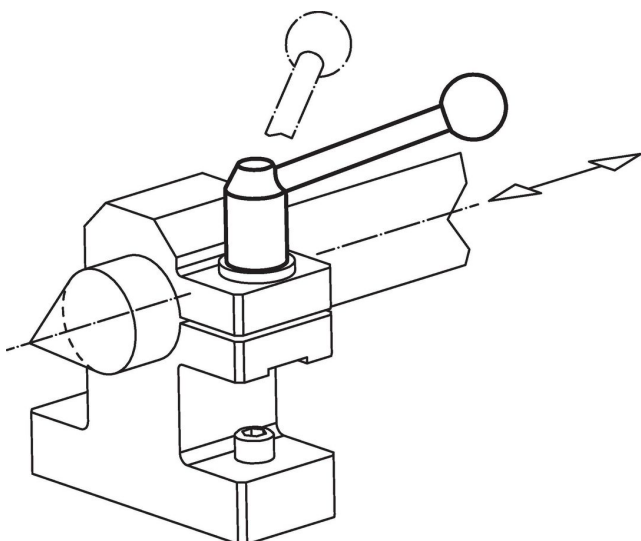

## Compliance

### RoHS compliant

Contains lead - compliant according to exceptions 6a / 6b / 6c.

### Contains SVHC substances >0,1% w/w

Contains lead - SVHC list [REACH] as of 27.06.2024.

### Contains Proposition 65 substances



Lead can cause cancer and reproductive harm from exposure  
<https://www.P65Warnings.ca.gov/>

### Free from Conflict Minerals

This product does not contain any substances designated as "conflict minerals" such as tantalum, tin, gold or tungsten from the Democratic Republic of Congo or adjacent countries.