

## Adjustable Clamping Levers · with clamping screw

24410.1393



### Product Description

Adjustable clamping levers find versatile applications when the area of use is confined or a specific lever position is required.

#### Material

##### Lever

- Zinc die-cast, plastic coated, silver, similar to RAL 9006, matt structure

##### Inner parts

- Steel, blackened, quality 5.8

##### Screw

- Steel, blackened, quality 5.8

#### Operation

**By lifting the lever** the serrations are disengaged. The lever can be positioned by the serrations. On releasing the lever, the serrations are automatically re-engaged.

#### More information

#### Notes

The screw part can be exchanged.

#### References

The version with ball-headed (picture 3) can be combined with the thrust piece, plastic (EH 22570.).

#### Further products

- Thrust Pads, plastic

### Drawing

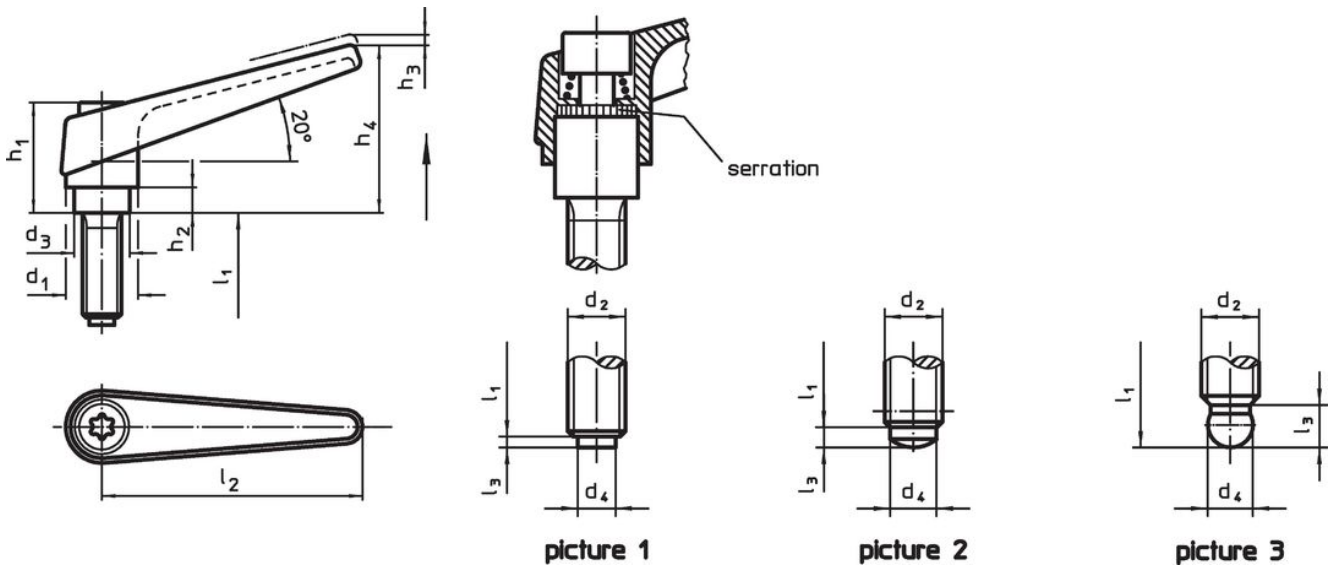

### Order information

Dimensions											[g]	Art. No.
d <sub>1</sub>	d <sub>2</sub>	l <sub>1</sub>	d <sub>3</sub>	d <sub>4</sub>	h <sub>1</sub>	h <sub>2</sub>	h <sub>3</sub>	h <sub>4</sub>	l <sub>2</sub>	l <sub>3</sub>		
with brass thrust pin – picture 1, silver												
18	M8	63	13.5	5	31	6.5	3	45	62	1.3	88	24410.1393

## Compliance

### RoHS compliant

Contains lead - compliant according to exceptions 6a / 6b / 6c.

### Contains SVHC substances >0,1% w/w

Contains lead - SVHC list [REACH] as of 23.01.2024.

### Contains Proposition 65 substances



Lead can cause cancer and reproductive harm from exposure  
<https://www.P65Warnings.ca.gov/>

### Free from Conflict Minerals

This product does not contain any substances designated as "conflict minerals" such as tantalum, tin, gold or tungsten from the Democratic Republic of Congo or adjacent countries.