

U-Handles • diagonal

24300.0815



Product Description

U-handles are used, for example, on machine doors, furniture doors, cabinet doors, drawers and drawer units.

Material

Handle

- Stainless steel 1.4301, dull blasted

Drawing

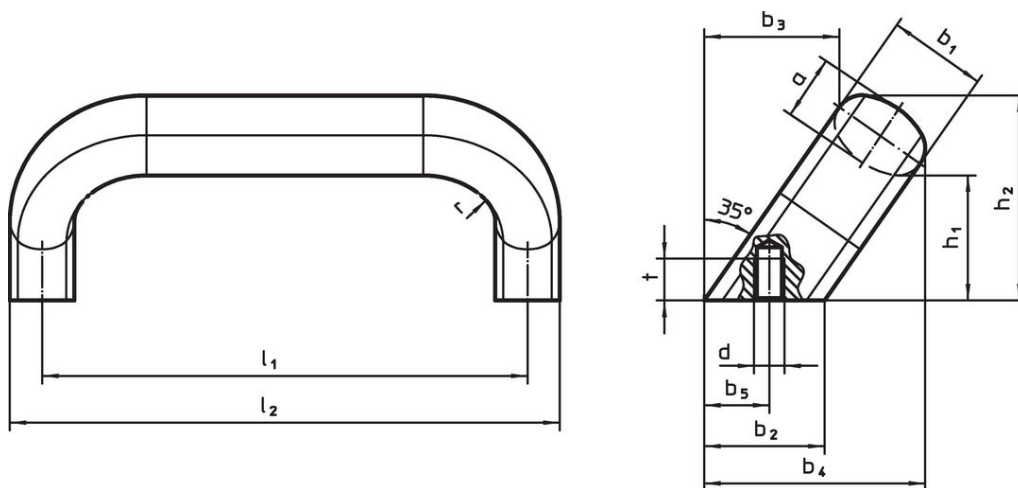

Order information

Dimensions													[g]	Art. No.
b_1	l_1 ± 0.25	l_2	a	b_2	b_3	b_4	b_5 $+1$	d	h_1	h_2	r	t		
26	128	145	17	32	34	57	18	M8	34	54	17	12	550	24300.0815

Compliance

RoHS compliant

Compliant according to Directive 2011/65/EU and Directive 2015/863.

Does not contain SVHC substances

No SVHC substances with more than 0.1% w/w contained - SVHC list [REACH] as of 23.01.2024.

Does not contain Proposition 65 substances

No Proposition 65 substances included.

<https://www.P65Warnings.ca.gov/>

Free from Conflict Minerals

This product does not contain any substances designated as "conflict minerals" such as tantalum, tin, gold or tungsten from the Democratic Republic of Congo or adjacent countries.