

U-Handles • diagonal

24300.0805



Product Description

U-handles are used, for example, on machine doors, furniture doors, cabinet doors, drawers and drawer units.

Material

Handle

- Stainless steel 1.4301, dull blasted

Drawing

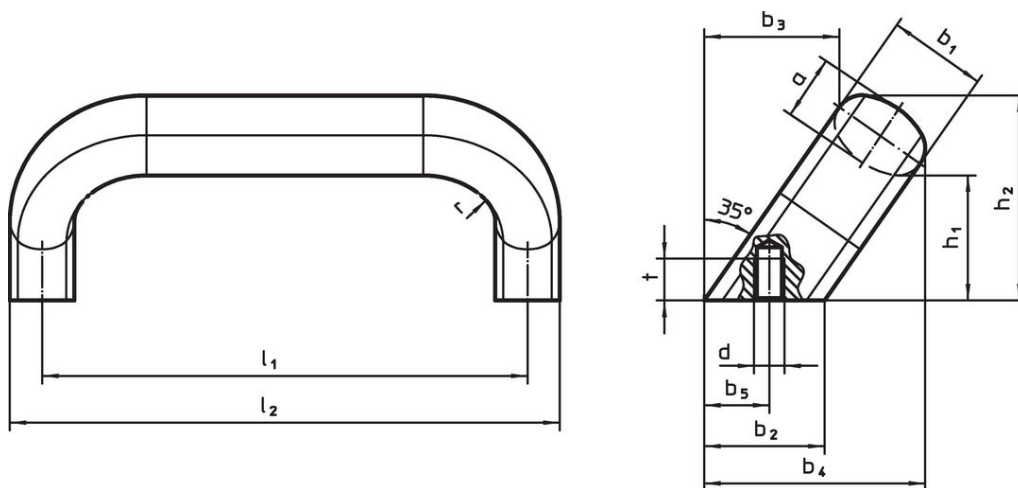

Order information

Dimensions													Art. No.	
b_1	l_1 ± 0.25	l_2	a	b_2	b_3	b_4	b_5 $+1$	d	h_1	h_2	r	t		
[mm]													[g]	
20	112	125	13	24	32	50	13.5	M6	32	48	13	10	301	24300.0805

Compliance

RoHS compliant

Compliant according to Directive 2011/65/EU and Directive 2015/863.

Does not contain SVHC substances

No SVHC substances with more than 0.1% w/w contained - SVHC list [REACH] as of 23.01.2024.

Does not contain Proposition 65 substances

No Proposition 65 substances included.

<https://www.P65Warnings.ca.gov/>

Free from Conflict Minerals

This product does not contain any substances designated as "conflict minerals" such as tantalum, tin, gold or tungsten from the Democratic Republic of Congo or adjacent countries.