

U-Handles • front mounting

24300.0113



Product Description

U-handles are used, for example, on machine doors, furniture doors, cabinet doors, drawers and drawer units.

These U-handles are characterised by their ergonomic profile design with very high stability and their simple and timeless design.

Material

Handle

- Aluminium, drawn, bright, vibratory grinded

Assembly

Mounting is done from the operating side by means of a cylinder screw.

Drawing

bore for
cylinder head stud
ISO 4762-M5/M6

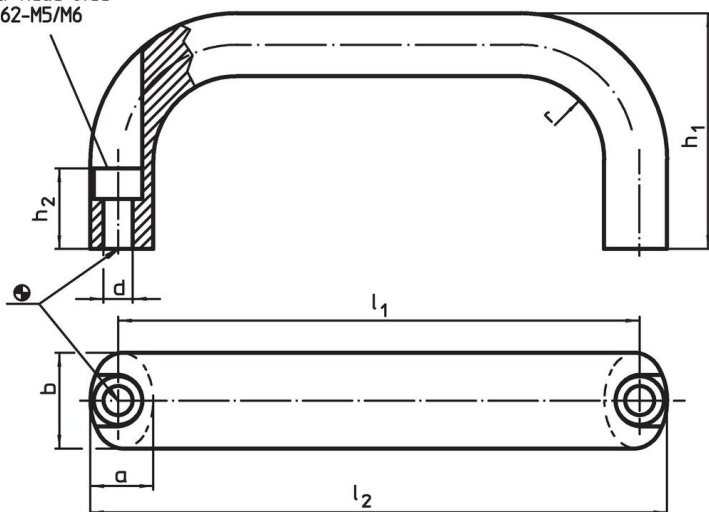

Order information

b	l ₁ ±0.25	l ₂	Dimensions					For cylinder screw	[g]	Art. No.
			a	d	h ₁	h ₂	r			
			[mm]					[mm]		
Aluminium Al										
20	117	129	13	5.4	49	19	13	M5	84	24300.0113

Application example

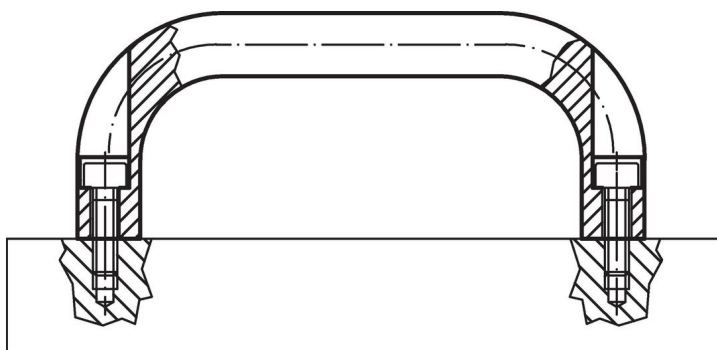

Compliance

RoHS compliant

Compliant according to Directive 2011/65/EU and Directive 2015/863.

Does not contain SVHC substances

No SVHC substances with more than 0.1% w/w contained - SVHC list [REACH] as of 27.06.2024.

Does not contain Proposition 65 substances

No Proposition 65 substances included.

<https://www.P65Warnings.ca.gov/>

Free from Conflict Minerals

This product does not contain any substances designated as "conflict minerals" such as tantalum, tin, gold or tungsten from the Democratic Republic of Congo or adjacent countries.