

Retaining Latches · double-sided

24100.0651



Product Description

To be used for door locking, drawers and as handling aid etc.
The retaining catch is indexing 4 x 90°.

Material

Lever

- Zinc die-cast, silver, similar to RAL 9006

Inner parts

- Dry powdered metal

Screw

- Stainless steel A2 (ISO 10642)

Drawing

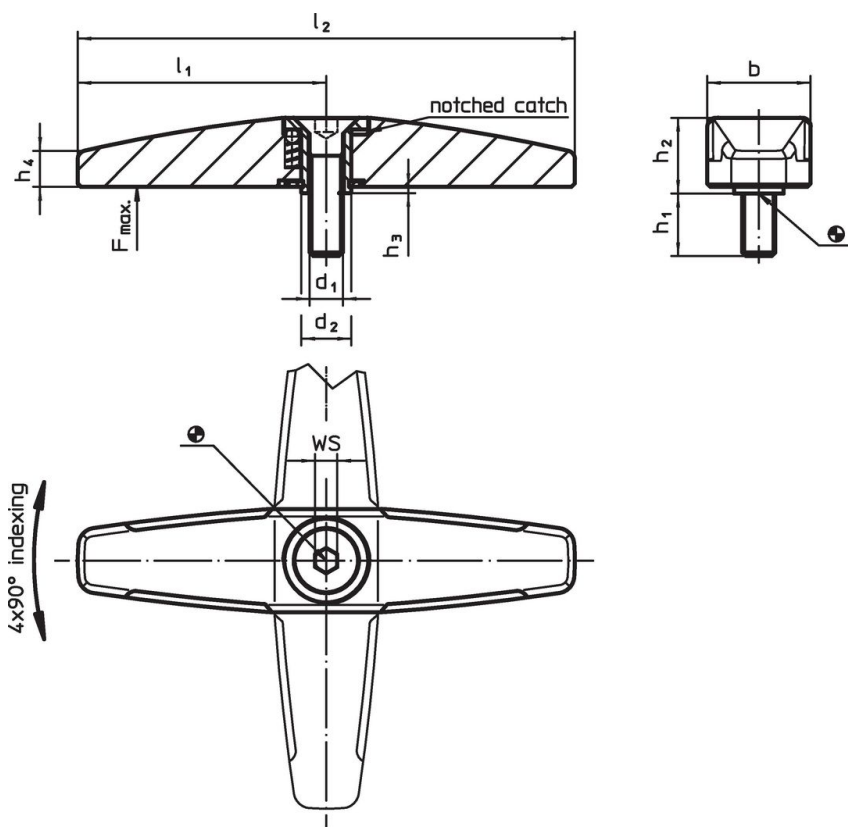

Order information

d ₁	d ₂	l ₁	l ₂	Dimensions						WS	Load capacity max.	Art. No.
				b	h ₁	h ₂	h ₃	h ₄	[mm]			
silver												
M8	14	65	130	25.2	14	15.8	0.8	9	5	1000	225	24100.0651

Application example

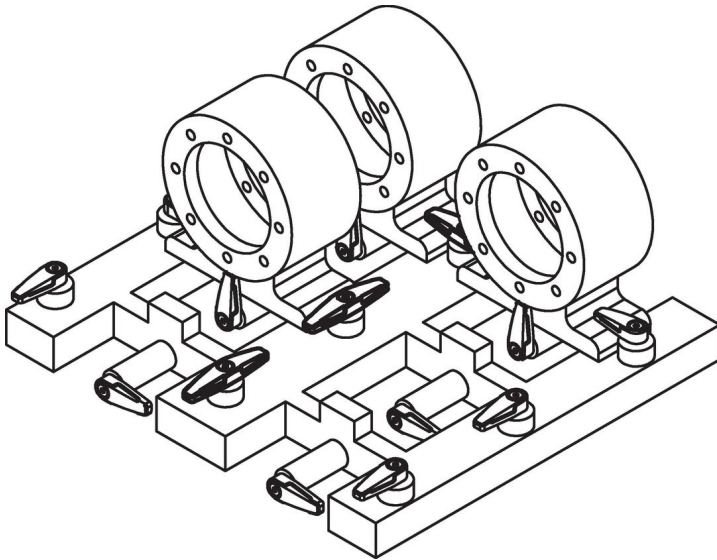

Compliance

RoHS compliant

Compliant according to Directive 2011/65/EU and Directive 2015/863.

Does not contain SVHC substances

No SVHC substances with more than 0.1% w/w contained - SVHC list [REACH] as of 23.01.2024.

Does not contain Proposition 65 substances

No Proposition 65 substances included.

<https://www.P65Warnings.ca.gov/>

Free from Conflict Minerals

This product does not contain any substances designated as "conflict minerals" such as tantalum, tin, gold or tungsten from the Democratic Republic of Congo or adjacent countries.