

Height Adapters • for compact clamp

23690.0112



Product Description

The height adapter for compact clamps allows a clamping height increase and has the following characteristics:

- Continuous covering of clamping height
- T-slot in the height adapter allows exact positioning by moving the compact clamp at specified grid spacings
- Height can be expanded user-defined

Material

- Heat-treated steel, black coated

Drawing

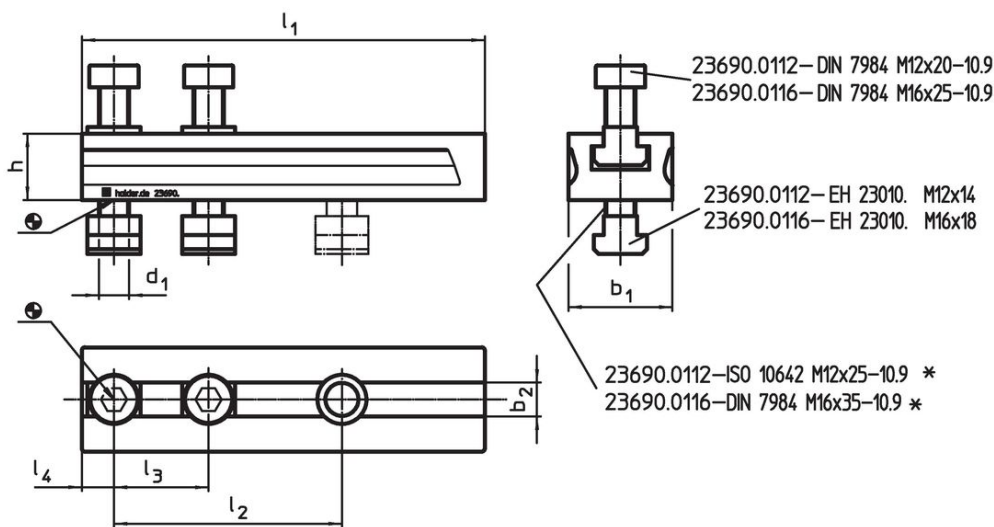

* When using more height adapters the screws ISO 10642 or DIN 7984 have to be replaced by screws extended by the dimension h.

Order information

Dimensions								[g]	Art. No.
d_1	l_1	l_2 +1	l_3	l_4	h	b_1	b_2 H12		
M12	134	70	50	13	20	45	14	874	23690.0112

Application example

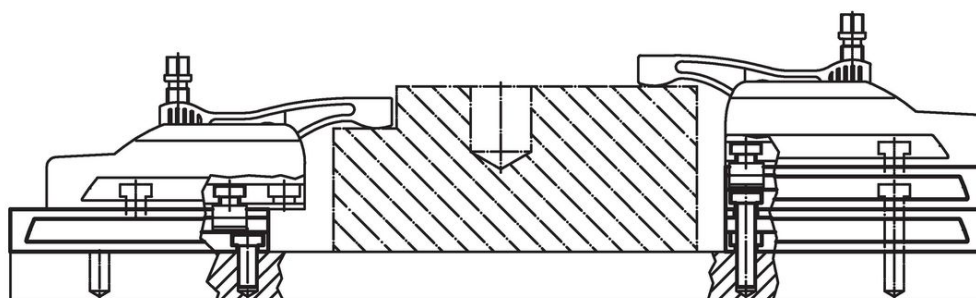
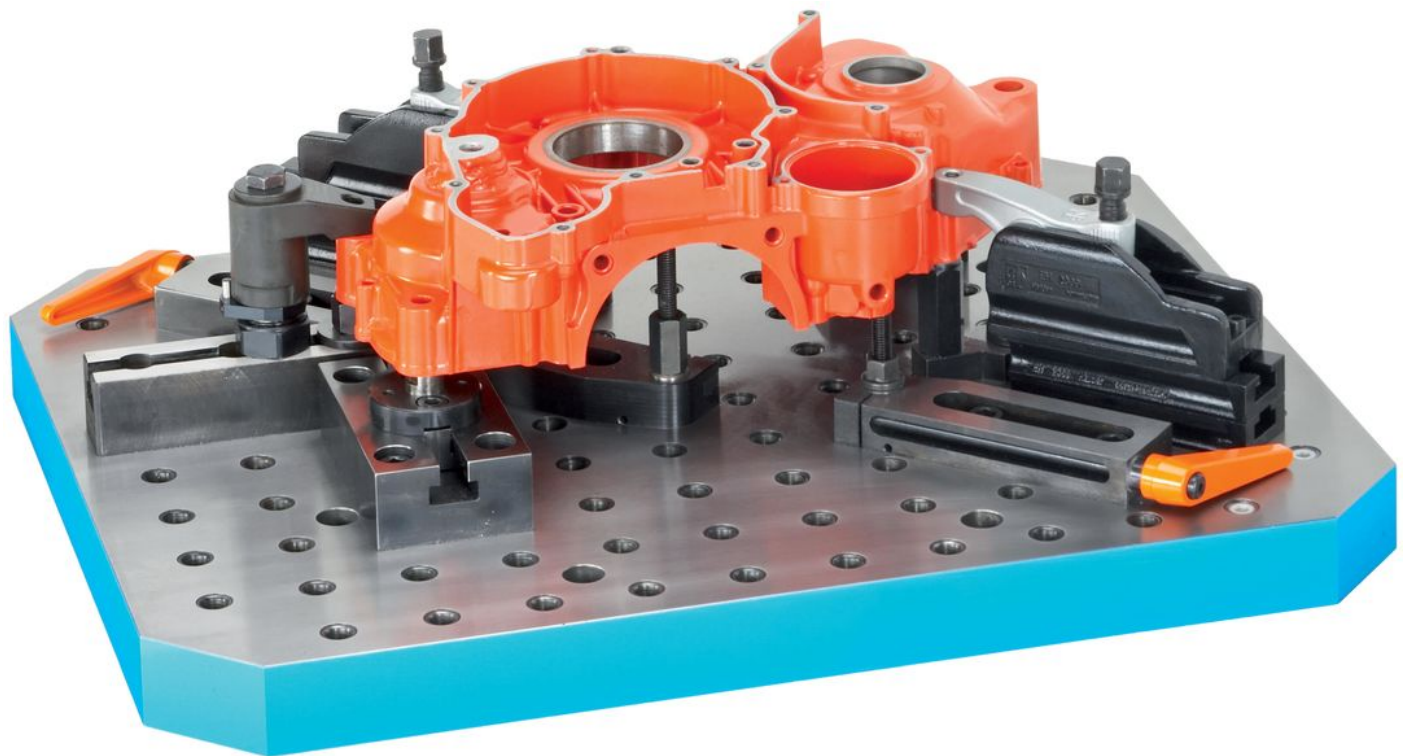
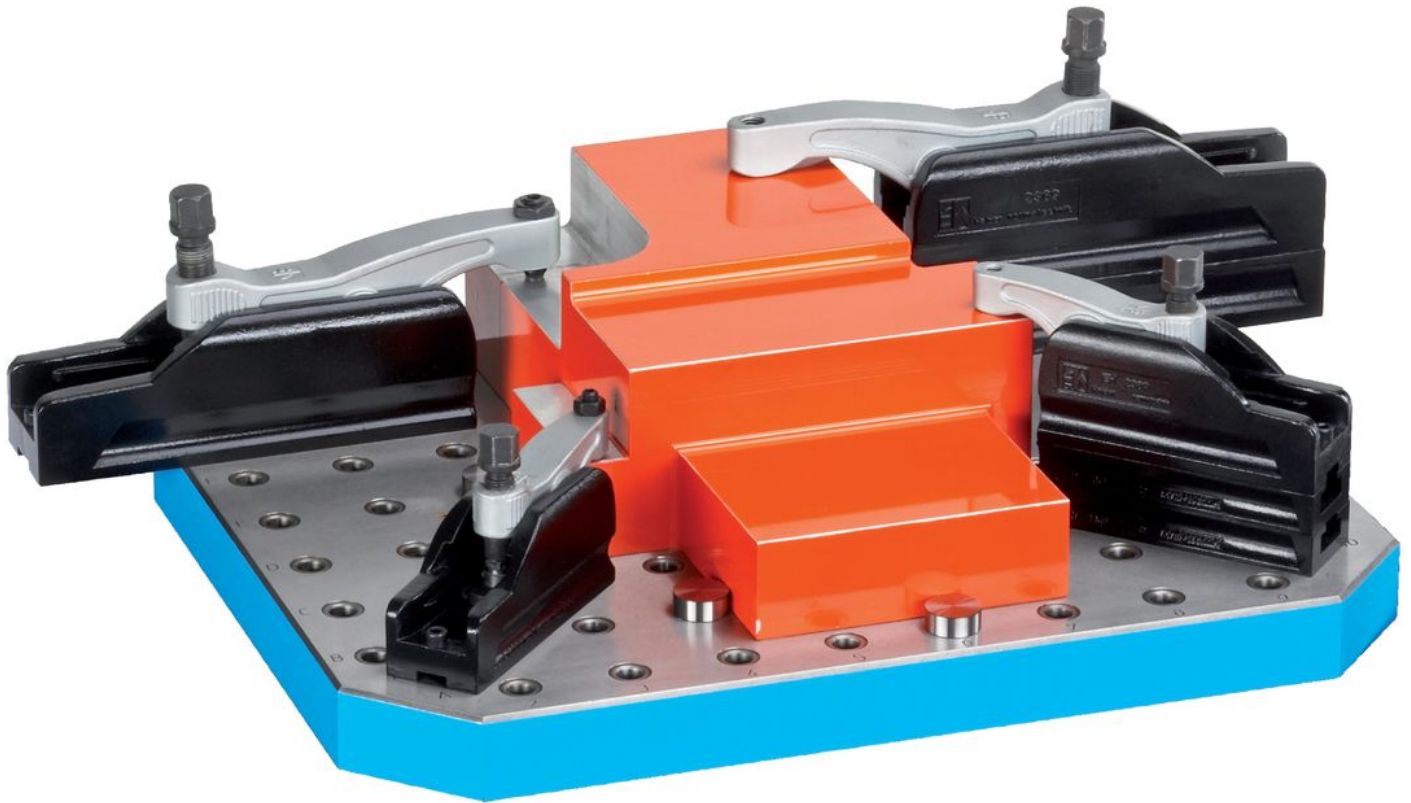

Compliance

RoHS compliant

Compliant according to Directive 2011/65/EU and Directive 2015/863.

Does not contain SVHC substances

No SVHC substances with more than 0.1% w/w contained - SVHC list [REACH] as of 27.06.2024.

Does not contain Proposition 65 substances

No Proposition 65 substances included.

<https://www.P65Warnings.ca.gov/>

Free from Conflict Minerals

This product does not contain any substances designated as "conflict minerals" such as tantalum, tin, gold or tungsten from the Democratic Republic of Congo or adjacent countries.