

Eccentric Clamps

23410.0051



Product Description

Eccentric clamps enable fast and safe clamping and releasing with a relatively large adjustment range and high tensioning force. The eccentric plain washer enables a stepless radial clamping effect in any clamping position. Furthermore, the eccentric clamp is self-locking. The clamp can be used as a stepless stop by removing the thrust washer.

Material

Gear lever handle

- Stainless steel 1.4305, dull blasted

Body

- Stainless steel 1.4305, nickel-plated

Screw

- Stainless steel 1.4021, heat-treated, nickel-plated

Ball knob

- Thermosetting plastic PF 31, black, DIN 319

Assembly

Fix with screw bolt M 10 (WS 6). Ensure a tightening torque of max. 40 Nm.

Operation

The screw bolt and the washer are adjustable. Once screwed in, the clamping catch can easily be turned to the desired position. For Art. No. 23410.0050 / .0051, the serration helps to put the tension lever to the preferred position.

More information

Notes

Left turn type can be supplied on request.

Drawing

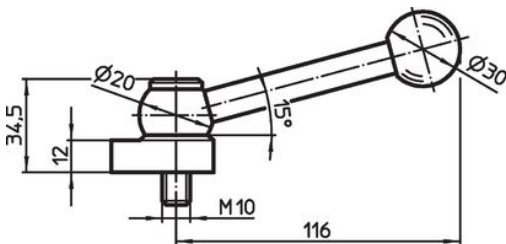

picture 1

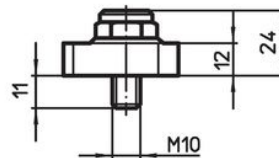

picture 2

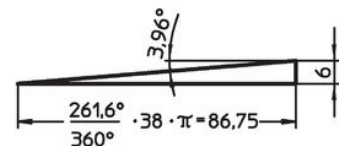
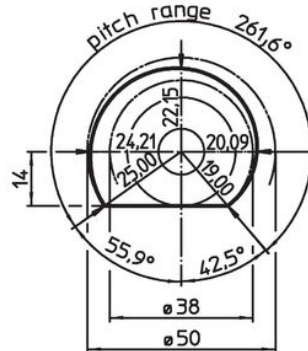
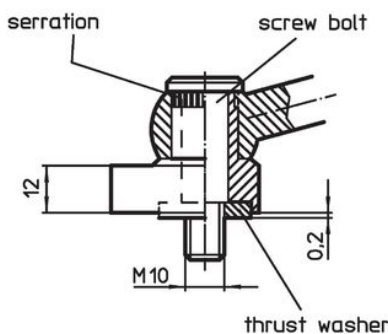
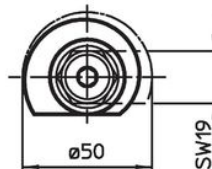
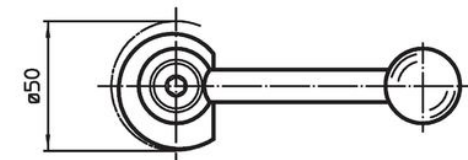

Order information

Art. No.
 [g] with tension lever – picture 1, Stainless steel
317
23410.0051

Compliance

RoHS compliant

Compliant according to Directive 2011/65/EU and Directive 2015/863.

Does not contain SVHC substances

No SVHC substances with more than 0.1% w/w contained - SVHC list [REACH] as of 23.01.2024.

Does not contain Proposition 65 substances

No Proposition 65 substances included.

<https://www.P65Warnings.ca.gov/>

Free from Conflict Minerals

This product does not contain any substances designated as "conflict minerals" such as tantalum, tin, gold or tungsten from the Democratic Republic of Congo or adjacent countries.