

Clamping Claws

23370.0140



Product Description

Clamping claws are used as precision clamping element in conventional fixtures. A locating hole is provided in the body of the fixture. The hole depth has to be adapted to the desired clamping height.

For the version with ground support surface (picture 1), a support can be attached to the rounded claw part (radius 22) to absorb the counter force. This support can be flat, half-rounded or V-shaped.

For the version with positioning bushing (picture 2), a support to absorb the counterforce is not necessary. The positioning bushing, which must be inserted into the fixture, serves as a support for the clamping claw. This bushing is included in the scope of delivery and can also be ordered separately as an accessory.

Clamping is achieved by means of an enclosed hexagon screw DIN 933 (ISO 4017).

Material

Bushing

- Case-hardened steel, case-hardened

Body

- Case-hardened steel, case-hardened, blackened and ground

Disc

- Heat-treated steel, tempered, punched, mechanically trued, phosphatized

Spring

- Spring steel wire

Clamping screw

- Heat-treated steel

More information

Notes

The tightening torque depends on the specific mounting situation.

References

The clamping height can be reduced by using clamping inserts, e.g. EH 22730.

Drawing

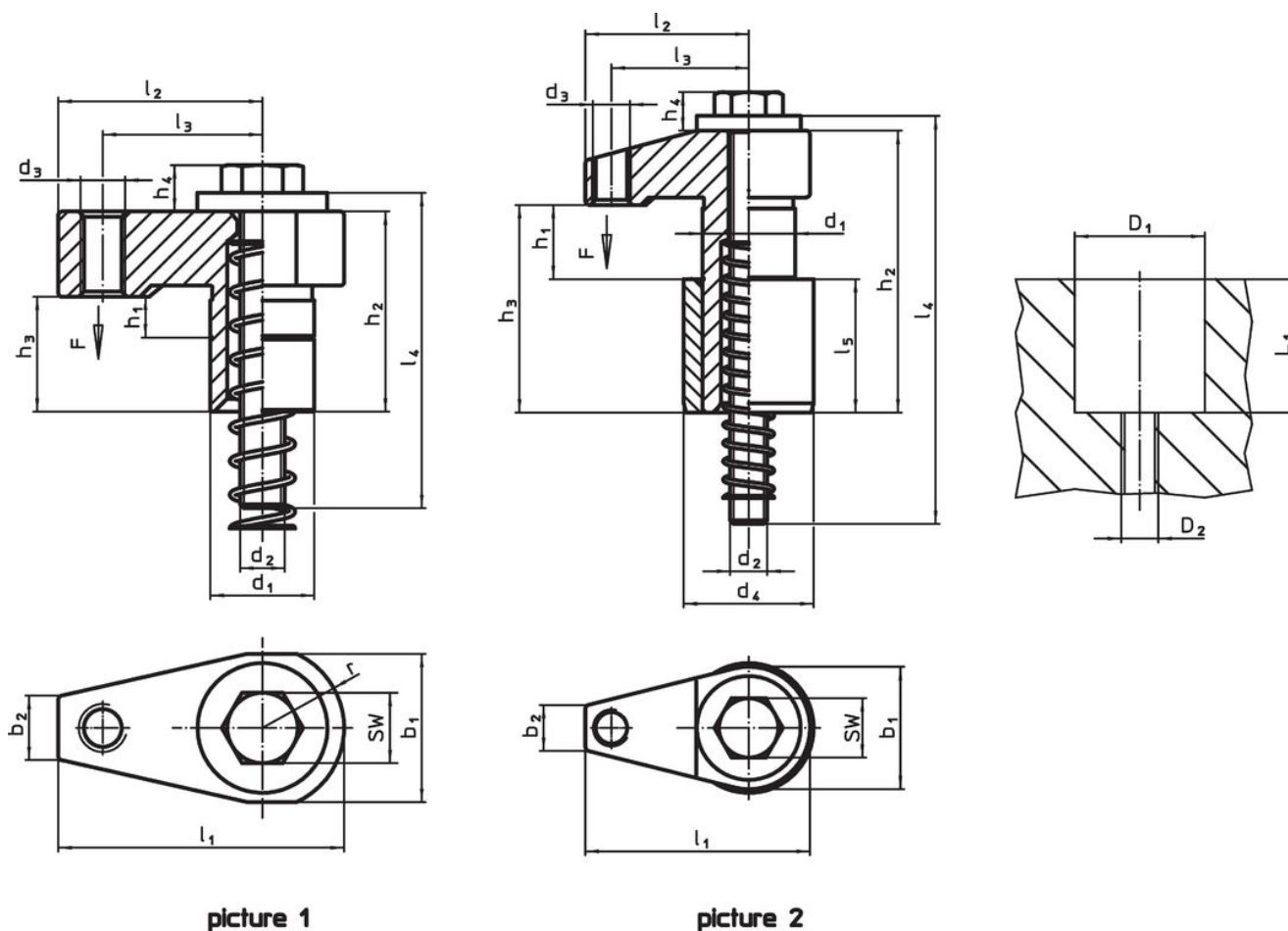

Order information

d ₁ f7	h ₁	b ₁	d ₂	d ₃	Dimensions										Stroke [mm]	WS [mm]	Location hole			Clamping force [kN]	Tightening torque max. [Nm]	Art. No.
					d ₄ n6	h ₂	h ₃	h ₄	l ₁	l ₂	l ₃	l ₄	l ₅	D1 H7			D2	L1	[g]			
with positioning bushing – picture 2																						
25	0 – 15	33	M10	M10	35	60	40	11	60.5	43.5	37	90	36	15	16	35	M10	41	7.5	20	483	23370.0140

Application example



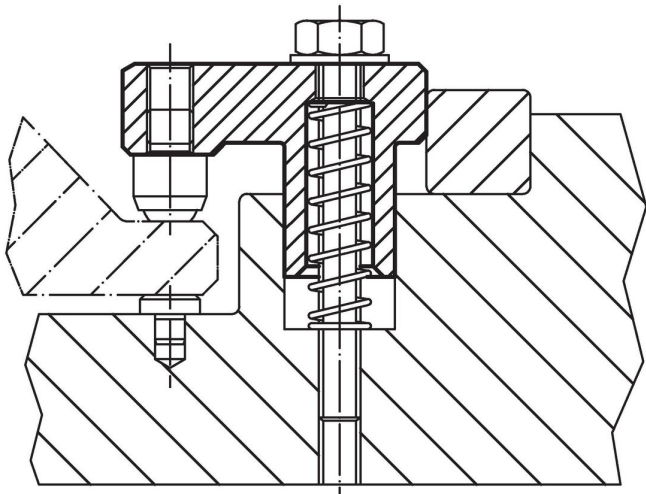

Compliance

RoHS compliant

Contains lead - compliant according to exceptions 6a / 6b / 6c.

Contains SVHC substances >0,1% w/w

Contains lead - SVHC list [REACH] as of 27.06.2024.

Contains Proposition 65 substances



Lead can cause cancer and reproductive harm from exposure

<https://www.P65Warnings.ca.gov/>

Free from Conflict Minerals

This product does not contain any substances designated as "conflict minerals" such as tantalum, tin, gold or tungsten from the Democratic Republic of Congo or adjacent countries.