

Shaft Clamps

23341.0508



Product Description

Shaft clamps are used to clamp round workpieces, e.g. shafts, axels, tubes or rods both axially and radially.

Material

Body

- Stainless steel 1.4305

Spring

- Stainless steel

Clamping screw

- Steel, zinc-plated
- Stainless Steel

Assembly

- Expand the clamping jaws to the diameter of the shaft to be clamped.
- Insert shaft clamp into hole using the assembly tool.
- Insert and position the shaft.
- Clamp using cylinder screw WS (observe tightening torque).

More information

Notes

The thread d_3 serves to hold the assembly tool (optional).

Drawing

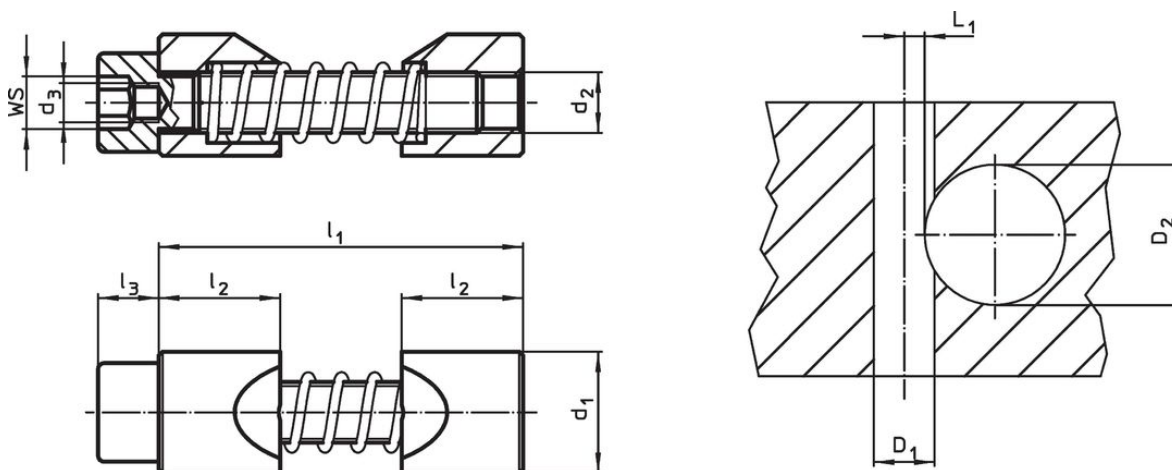

Order information

d ₁ h11	d ₂	Dimensions			WS	Tightening torque max.	Location hole			Art. No.		
		d ₃	l ₁ max.	l ₂			l ₃	Hub bore D ₁ H7	Shaft diameter D ₂		L ₁ +0.2	
		[mm]			[mm]	[Nm]				[g]		
8	M4	M2,5	27	8	4	3	2.9	8	6 – 10	2.8	8	23341.0508

Accessories

	WS	d		Art. No.
	[mm]	[mm]	[g]	
special hexagon key				
	3	M2,5	5	23341.1008

Application example



Compliance

RoHS compliant

Compliant according to Directive 2011/65/EU and Directive 2015/863.

Does not contain SVHC substances

No SVHC substances with more than 0.1% w/w contained - SVHC list [REACH] as of 23.01.2024.

Does not contain Proposition 65 substances

No Proposition 65 substances included.

<https://www.P65Warnings.ca.gov/>

Free from Conflict Minerals

This product does not contain any substances designated as "conflict minerals" such as tantalum, tin, gold or tungsten from the Democratic Republic of Congo or adjacent countries.