

Positioning Rings · for down-thrust clamp

23310.0345



Product Description

After aligning, the clamp positioning ring is fitted on the spindle with the effect, that repeated clamping is always exactly on the same point. The positioning ring is adjustable 360° on the down-thrust clamp. After mounting, the clamping claw can swing 110° to the left or right (only for the swiveling versions).

Material

- Steel, blackened

Assembly

Before mounting the positioning ring, pull-off the clamping claw of down-thrust clamp.

Drawing

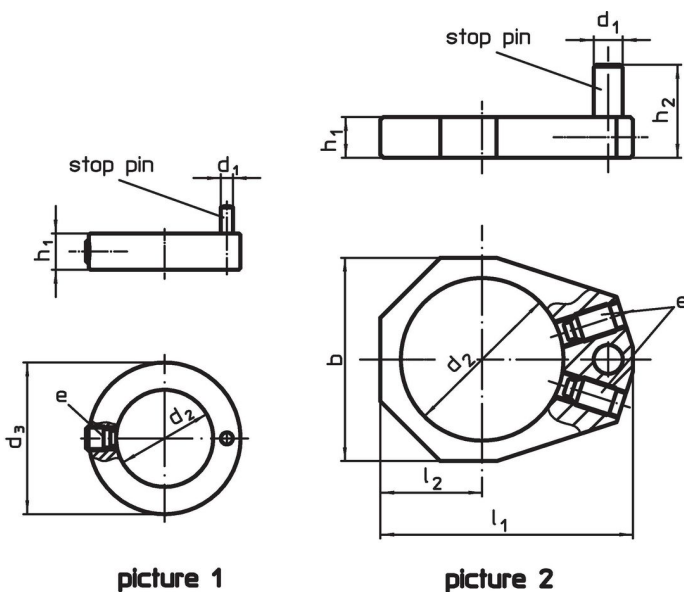

Order information

Dimensions						For down-thrust clamp	[g]	Art. No.
h_1	h_2	d_1	d_2	d_3	e			
for down-thrust clamps size 25 – picture 1								
6	10	2	16	25	22760.0040	23310.0027 - 23310.0029	14	23310.0345

Application example



Compliance

RoHS compliant

Contains lead - compliant according to exceptions 6a / 6b / 6c.

Contains SVHC substances >0,1% w/w

Contains lead - SVHC list [REACH] as of 23.01.2024.

Contains Proposition 65 substances



Lead can cause cancer and reproductive harm from exposure
<https://www.P65Warnings.ca.gov/>

Free from Conflict Minerals

This product does not contain any substances designated as "conflict minerals" such as tantalum, tin, gold or tungsten from the Democratic Republic of Congo or adjacent countries.