

Eccentric Clamps

23271.0005



Product Description

The eccentric clamp allows clamping with pull-down effect on different workpiece forms at low height.

Material

- Case-hardened steel, case-hardened and blue zinc-plated

Assembly

1. Manufacture a thread with the corresponding distance L_2 / L_3 to the workpiece.
2. Screw in the eccentric clamp at the necessary height and set it relative to the workpiece with its flat side.
3. Insert the workpiece and tighten the clamping pin using the internal hexagon. The proper tension is achieved after approx. 1/3 turn.

The threaded hole must be lubricated on a regular basis.

The rotational movement during tightening must always be completed towards the stops in order to prevent the workpiece from turning away from the stops.

Drawing

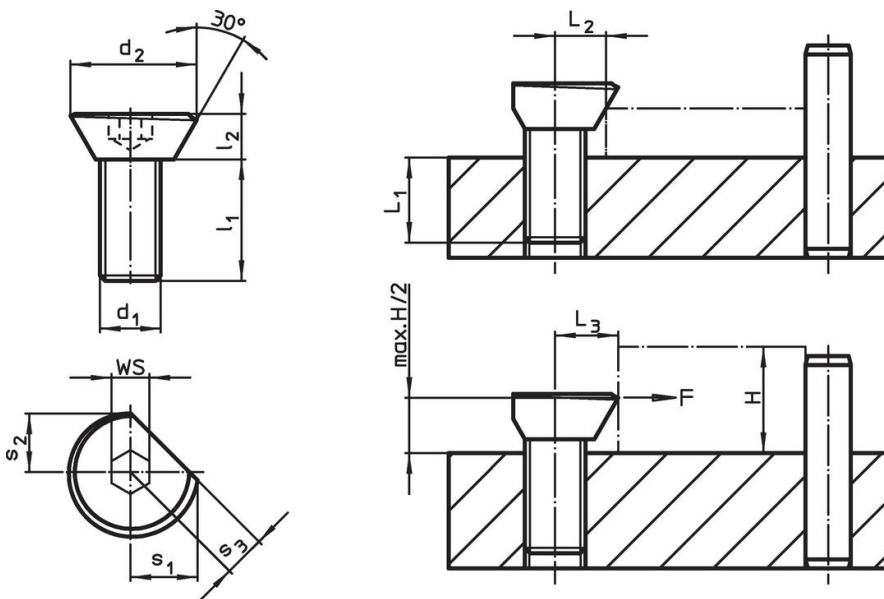

Order information

Dimensions							L_1	L_2	L_3	WS	Clamping force max.	Tightening torque max.	Art. No.	
d_1	d_2	l_1	l_2	s_1	s_2	s_3	[mm]	[mm]	± 0.2	[mm]	[kN]	[Nm]		[g]
M5	10.9	10	4	5.7	5	3.5	5	4.2	5.2	3	0.1	2	2.8	23271.0005

Application example



Compliance

Contains lead - compliant according to exceptions 6a / 6b / 6c.

Contains SVHC substances >0,1% w/w

Contains lead - SVHC list [REACH] as of 27.06.2024.

Contains Proposition 65 substances



Lead can cause cancer and reproductive harm from exposure
<https://www.P65Warnings.ca.gov/>