

Interchangeable Jaws • for vices, with pull-down effect

23231.0031



Product Description

These jaws are accessories for the clamping vice EH 23231..

Material

Jaw

- Case-hardened steel, case-hardened

Assembly

The base support (picture 1) is fixtured at the adapter of the clamping vice with the standardly delivered screws. The interchangeable jaws - held by 2 permanent magnets - can be inserted and exchanged with a manual handle.

Assembly-/Disassembly instruction:

1. Pull the jaw upwards with the manual handle until the alignment pin strikes against the slot.
2. Twist the jaw sideways and remove.
3. New jaw can be inserted.

More information

Notes

The delivery includes tightening screws.

Drawing

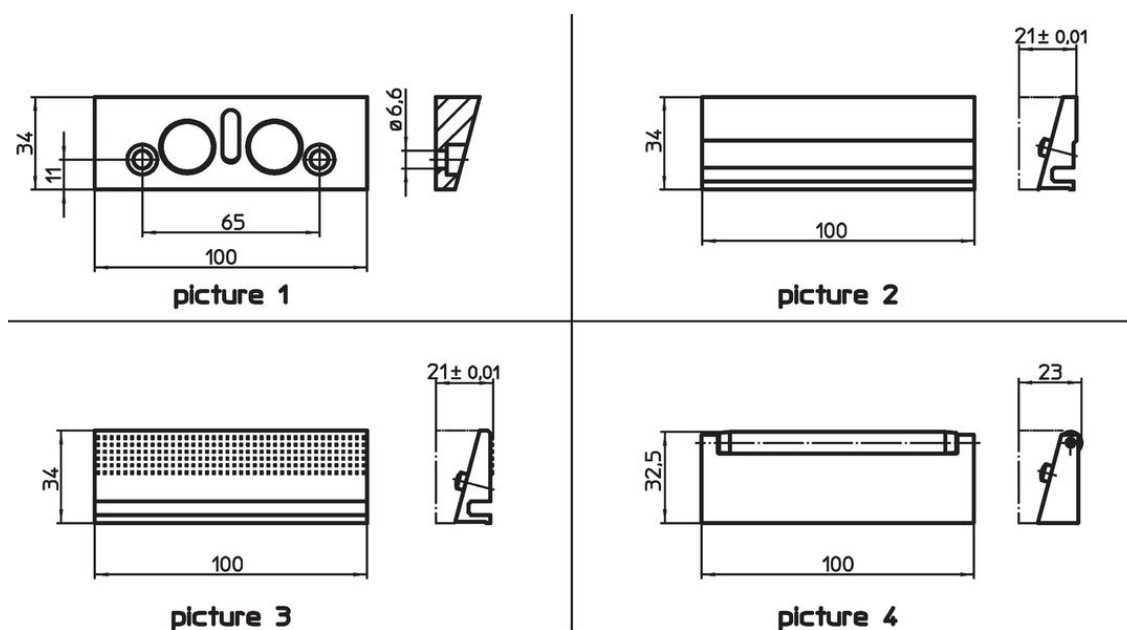

Order information

Nominal dimension [mm]	 [g]	Art. No.
interchangeable jaw, smooth of case-hardened steel – picture 2 100	246	23231.0031

Application example



Compliance

RoHS compliant

Compliant according to Directive 2011/65/EU and Directive 2015/863.

Does not contain SVHC substances

No SVHC substances with more than 0.1% w/w contained - SVHC list [REACH] as of 27.06.2024.

Does not contain Proposition 65 substances

No Proposition 65 substances included.

<https://www.P65Warnings.ca.gov/>

Free from Conflict Minerals

This product does not contain any substances designated as "conflict minerals" such as tantalum, tin, gold or tungsten from the Democratic Republic of Congo or adjacent countries.