

Holding Plates • for down-hold clamps

23210.0740



Product Description

By using the holding plates, the down-hold clamps can also be placed in any desired position across the T-slots.

Material

- Heat-treated steel, tempered, blackened

Drawing

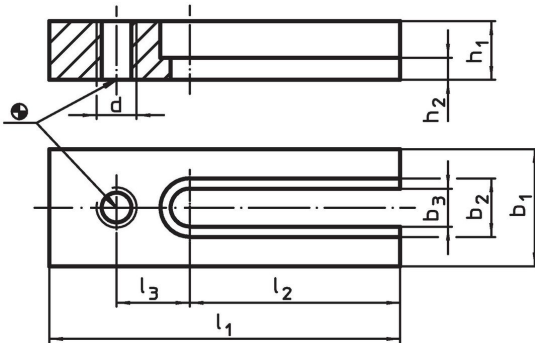

Order information

b ₁	b ₂	b ₃	d	Dimensions						For down-hold clamps	[g]	Art. No.
				h ₁	h ₂	l ₁	l ₂	l ₃	[mm]			
40	20	13	M12	20 -0.4 [mm]	7.5	120	72	25	M12	515	23210.0740	

Application example

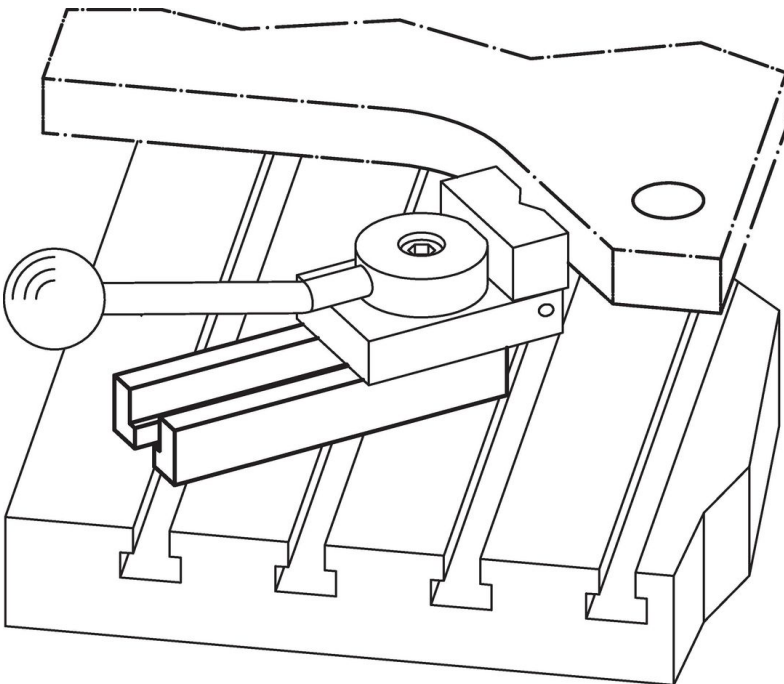

Compliance

RoHS compliant

Compliant according to Directive 2011/65/EU and Directive 2015/863.

Does not contain SVHC substances

No SVHC substances with more than 0.1% w/w contained - SVHC list [REACH] as of 27.06.2024.

Does not contain Proposition 65 substances

No Proposition 65 substances included.

<https://www.P65Warnings.ca.gov/>

Free from Conflict Minerals

This product does not contain any substances designated as "conflict minerals" such as tantalum, tin, gold or tungsten from the Democratic Republic of Congo or adjacent countries.