

Clamps · with exchangeable soft jaw

23190.0062



Product Description

This clamp (clamping claw) with exchangeable soft jaw is mainly used in mechanical clamping technology for clamping workpieces. The soft jaw made from brass or plastic protects the workpiece from damage.

Material

Soft jaw  
• Brass

Assembly

The soft jaws are mounted or disassembled with two screws. These are included in the scope of delivery.

Drawing

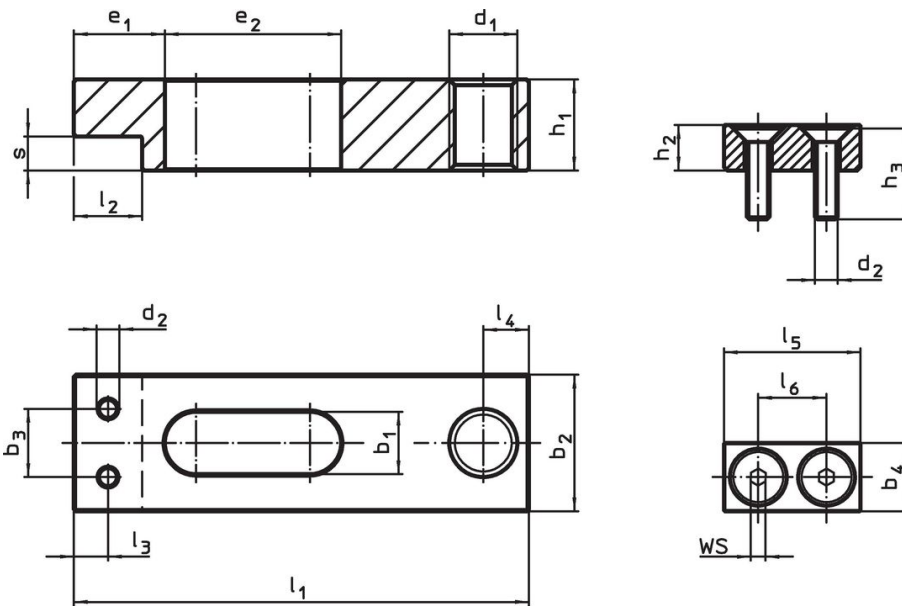

picture 1

picture 2

Order information

Nominal dimension $b_1$ +0.5 [mm]	Dimensions						WS [mm]	max. [°C]	[g]	Art. No.
	$b_4$	$d_2$	$h_2$	$h_3$	$l_5$	$l_6$				
soft jaw from brass – picture 2										
9	10	M3	6	12	20	11	2	250	11	23190.0062

## Application example

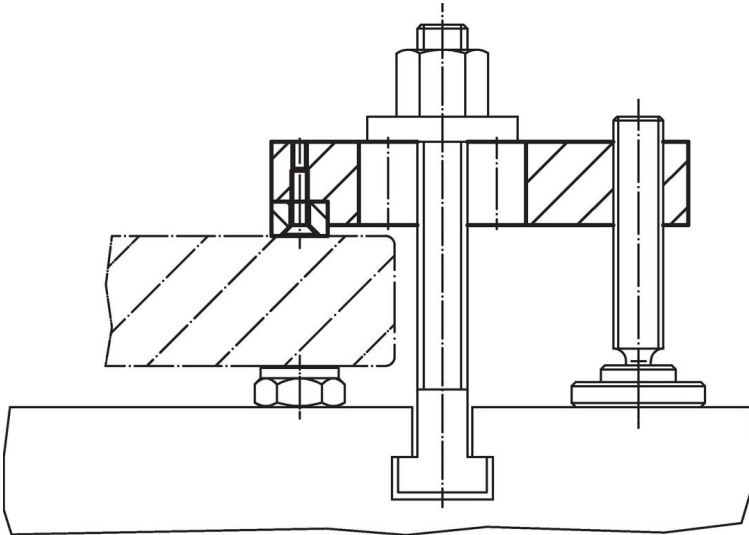

## Compliance

### RoHS compliant

Contains lead - compliant according to exceptions 6a / 6b / 6c.

### Contains SVHC substances >0,1% w/w

Contains lead - SVHC list [REACH] as of 23.01.2024.

### Contains Proposition 65 substances



Lead can cause cancer and reproductive harm from exposure  
<https://www.P65Warnings.ca.gov/>

### Free from Conflict Minerals

This product does not contain any substances designated as "conflict minerals" such as tantalum, tin, gold or tungsten from the Democratic Republic of Congo or adjacent countries.