

Locating Bushings · for positioning clamping pins, for press fit

23111.0862



Product Description

These locating bushes for positioning clamping pins are mounted in the counterpart.

Material

- Stainless steel 1.4112, hardened

Assembly

The press fit locating bushing for positioning clamping pins are inserted in the machine table or the base plate with light pressure.

Drawing

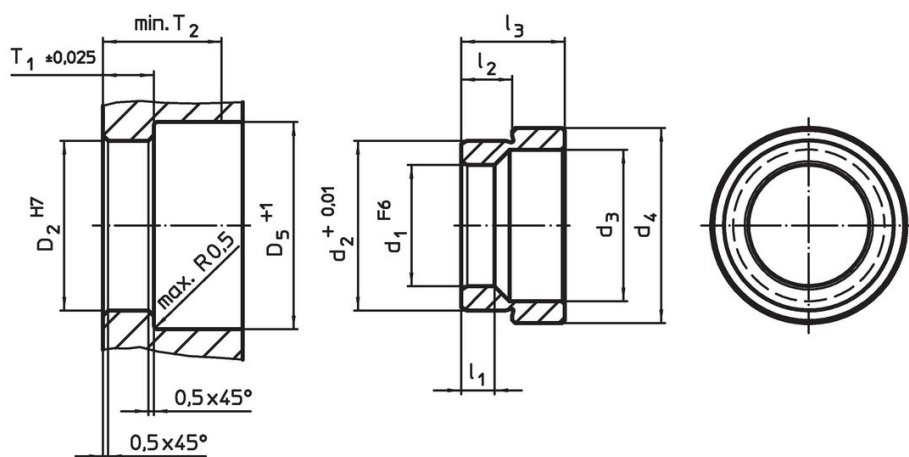

Order information

Dimensions							Location hole				[g]	Art. No.
d ₁	d ₂	d ₃	d ₄	l ₁	l ₂	l ₃	D ₂	D ₅	T ₁	T ₂		
F6	+0.01						H7	+1	±0.02	min.		
[mm]							[mm]					
Stainless steel												
16	22.03	20	28.6	5.25	6.9	12.1	22	31	7.25	22	22	23111.0862

Application example

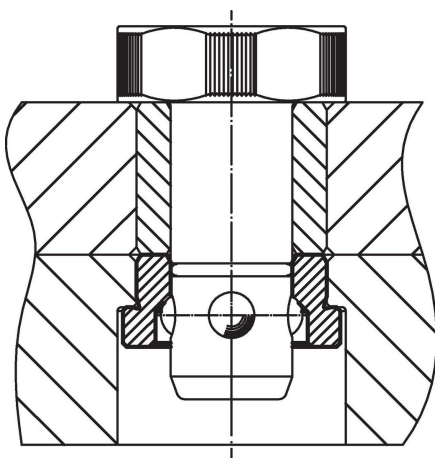

Compliance

RoHS compliant

Compliant according to Directive 2011/65/EU and Directive 2015/863.

Does not contain SVHC substances

No SVHC substances with more than 0.1% w/w contained - SVHC list [REACH] as of 23.01.2024.

Does not contain Proposition 65 substances

No Proposition 65 substances included.

<https://www.P65Warnings.ca.gov/>

Free from Conflict Minerals

This product does not contain any substances designated as "conflict minerals" such as tantalum, tin, gold or tungsten from the Democratic Republic of Congo or adjacent countries.