

Locating Bushings · for positioning clamping pins, for screw fit

23111.0782



Product Description

These locating bushes for positioning clamping pins are mounted in the counterpart.

Material

- Case-hardened steel, case-hardened, blackened

Assembly

The screw fit locating bushings for positioning clamping pins are inserted in the machine table or in the base plate and are screwed on. Supplied with mounting screws.

Drawing

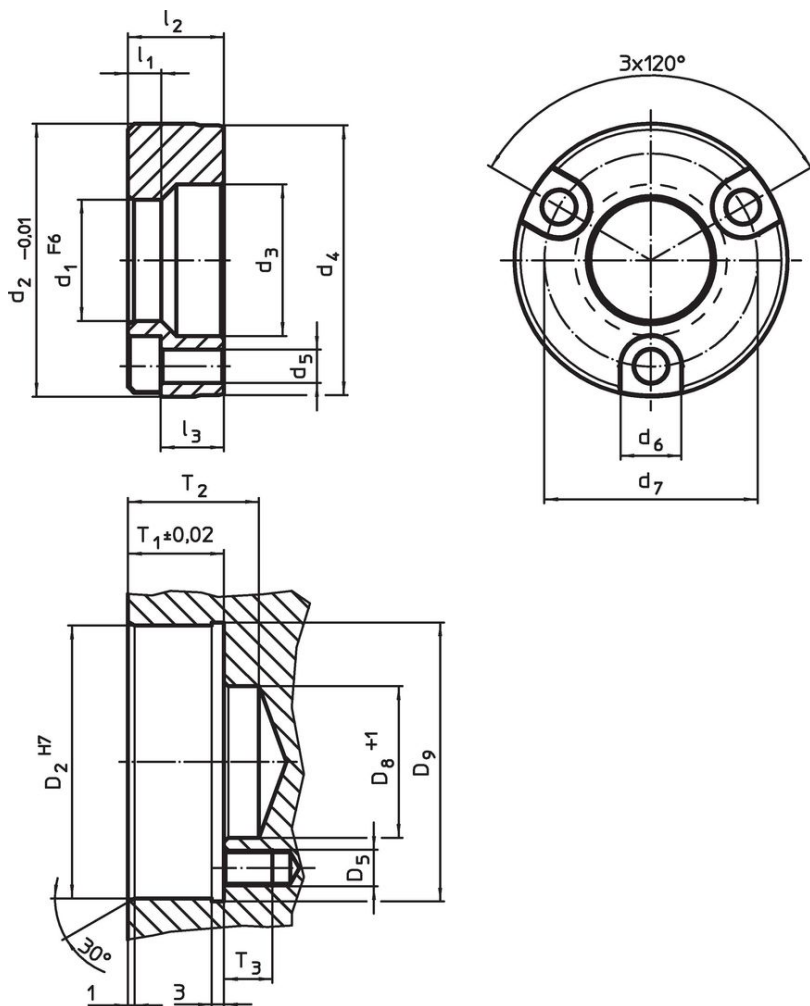

Order information

Dimensions										Location hole							[g]	Art. No.
d_1	d_2	d_3	d_4	d_5	d_6	d_7	l_1	l_2	l_3	D_2	D_5	D_8	D_9	T_1	T2	T3		
F6	-0.01								~	H7		+1		± 0.02				
[mm]										[mm]								
Case-hardened steel																		
16	36.99	20	36.5	4.5	8	29	5.25	11.56	7	37	M4	20	38.5	11.91	22	12	73	23111.0782

Application example



Compliance

RoHS compliant

Compliant according to Directive 2011/65/EU and Directive 2015/863.

Does not contain SVHC substances

No SVHC substances with more than 0.1% w/w contained - SVHC list [REACH] as of 23.01.2024.

Does not contain Proposition 65 substances

No Proposition 65 substances included.
<https://www.P65Warnings.ca.gov/>

Free from Conflict Minerals

This product does not contain any substances designated as "conflict minerals" such as tantalum, tin, gold or tungsten from the Democratic Republic of Congo or adjacent countries.